

VEGA 1D

**MEBLE-OKMED
DEMKO**
Jesteśmy razem 30 lat!

„MEBLE-OKMED” DEMKO - SPÓŁKA JAWNA
ul. Kolejowa 13, 14-500 Braniewo, POLSKA
www.mebleokmed.pl (+48) 55 243 27 26
firma@mebleokmed.pl

SERIA: .../...

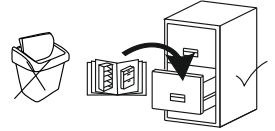



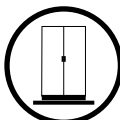
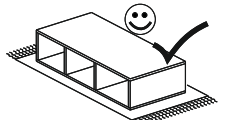
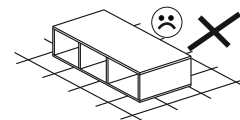
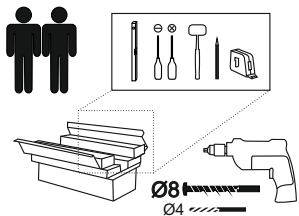
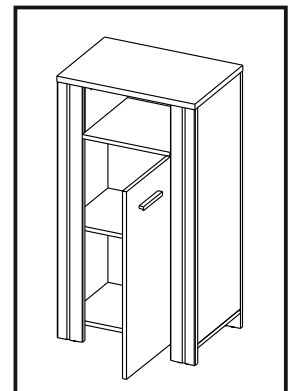
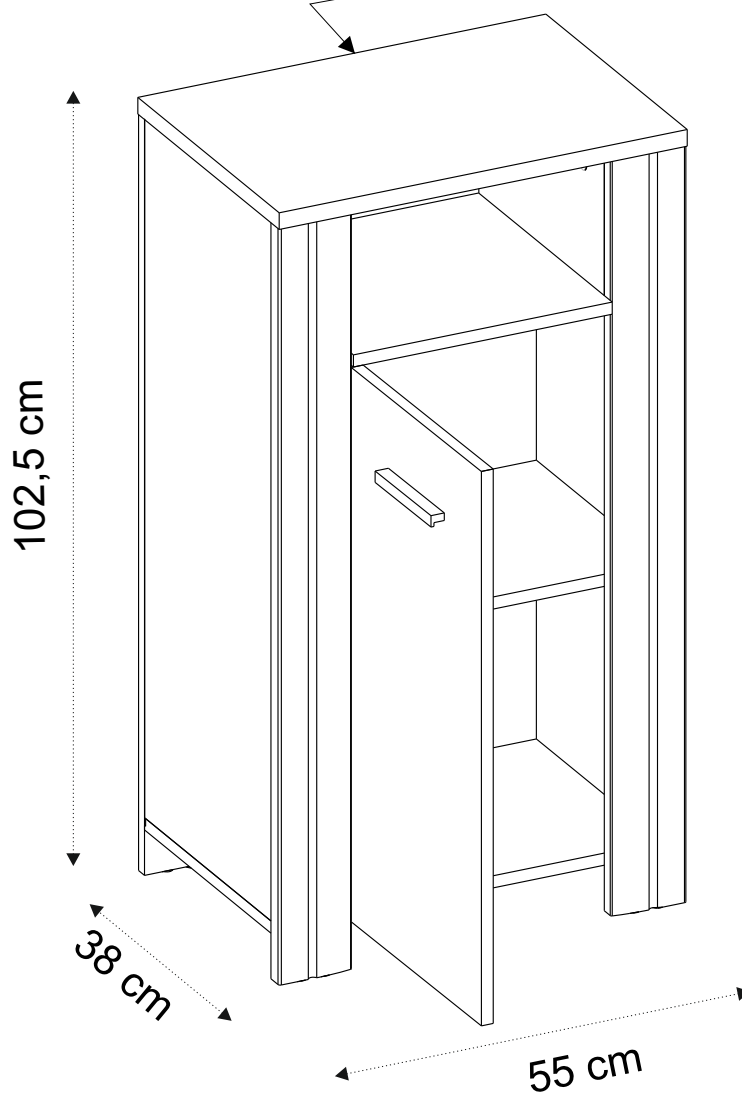



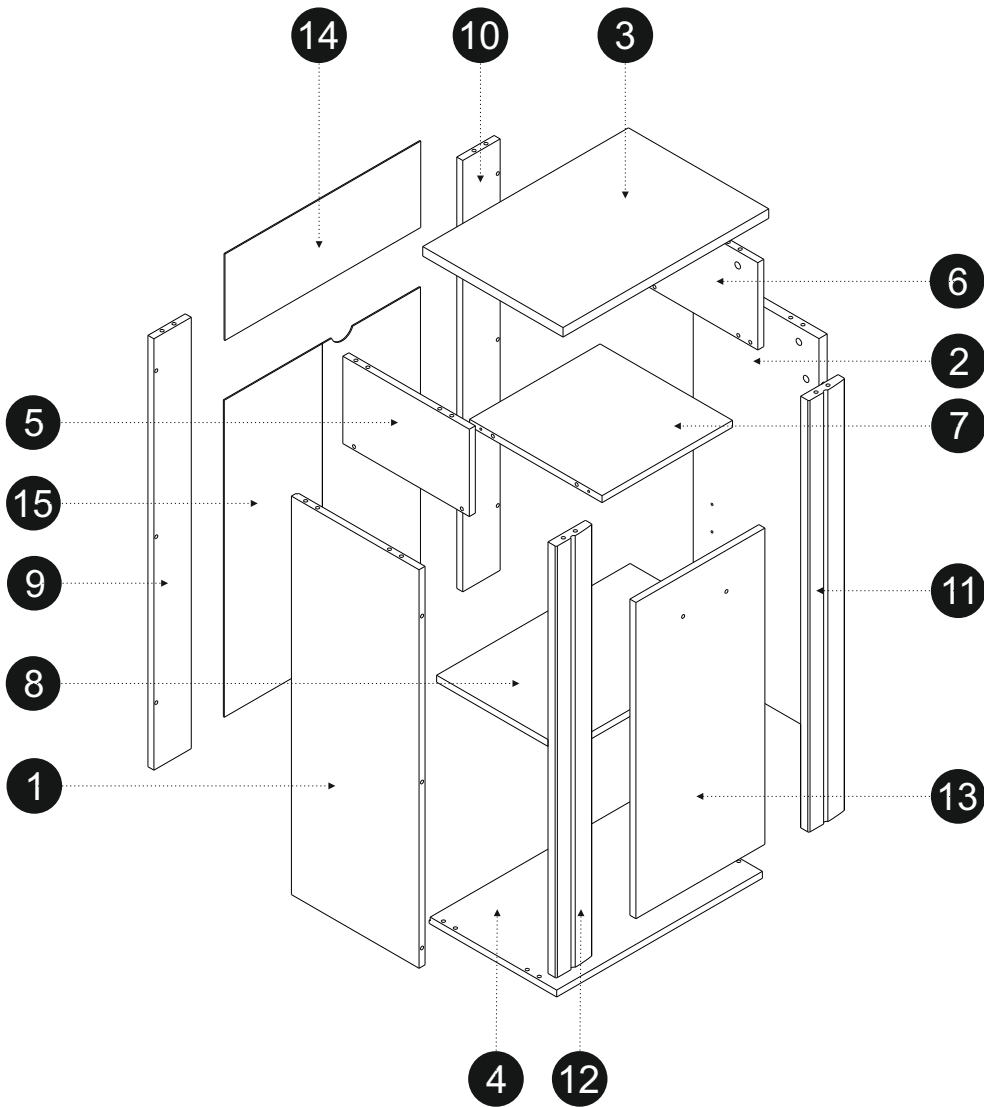



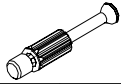



VEGA
Komoda 1D
SERIA: .../...
Front:
Kierunek:
MEBLE-OKMED
DEMKO
MEBLE OKMED Demko SP. z o.o.
14-500 Braniewo, ul. Kolejowa 13
Jesteśmy razem 30 lat!

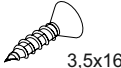
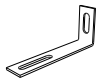

VEGA 1D





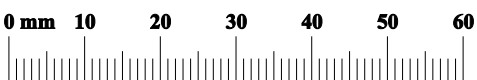

1/1				
	L [mm]	W [mm]	T [mm]	
1	922	341	16	x1
2	922	341	16	x1
3	550	381	22	x1
4	548	341	16	x1
5	338	202	16	x1
6	338	202	16	x1
7	354	349	16	x1
8	515	338	16	x1
9	998	100	16	x1
10	998	100	16	x1
11	998	100	22	x1
12	998	100	22	x1
13	732	345	16	x1
14	526	202	3	x1
15	736	526	3	x1

 8x35 KT1 20	 ZM1B 18	 ZM1A 18	 ZM1 8	 7x50 K1 14	 3,5x25 WU 2	 3x16 W1 6	 4x13 W4 4
 3,5x16 W11 2	 KS1 1	 PP 4	 KK1 1	 S1 1	 SG2 8	 PL1 3	 U75 1
 GTV 2	 08x40 KRW1 1						

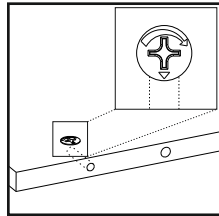
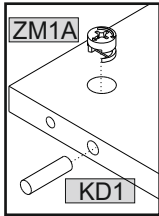
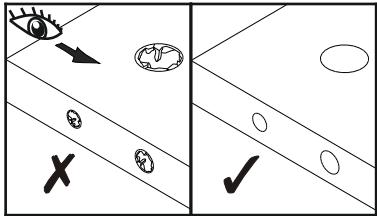



01

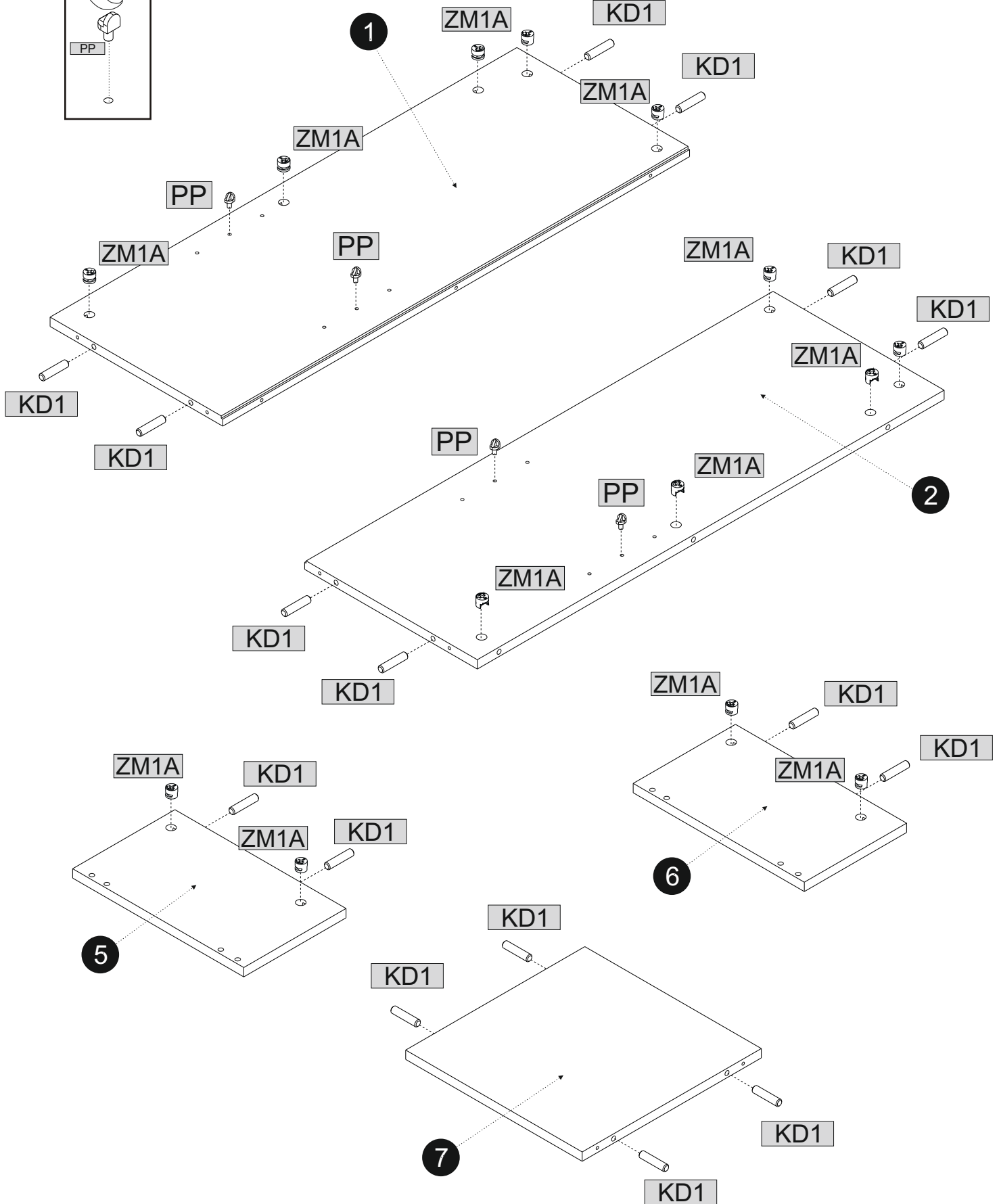
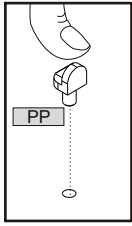

					
8x35					
KD1	16	ZM1A	14	PP	4

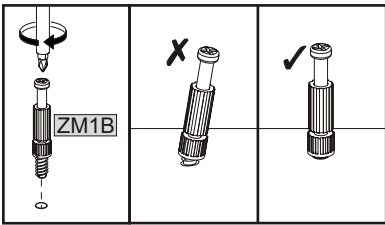

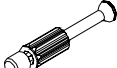

	8x35		
KD1	4	ZM1A	ZM1B 18

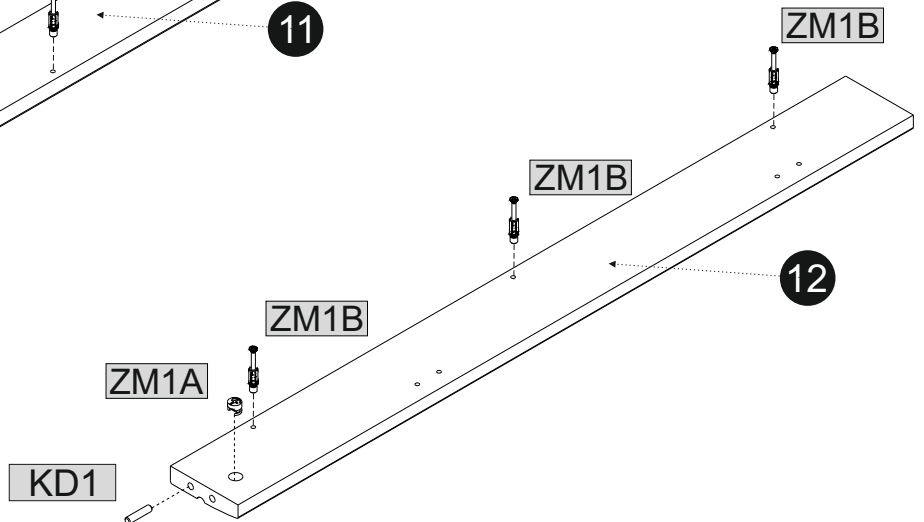
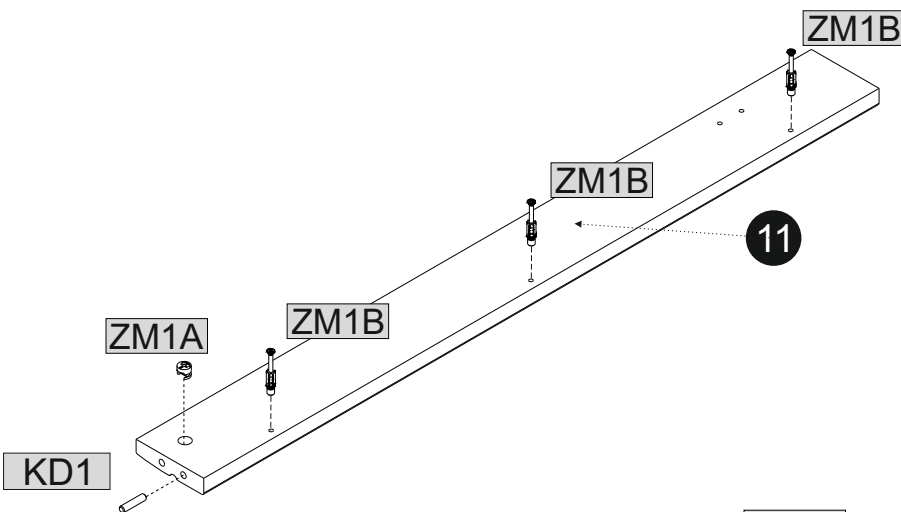
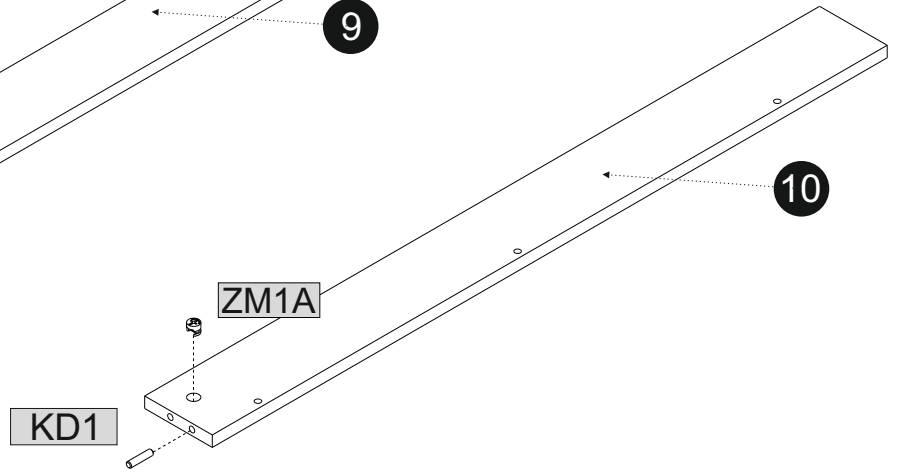
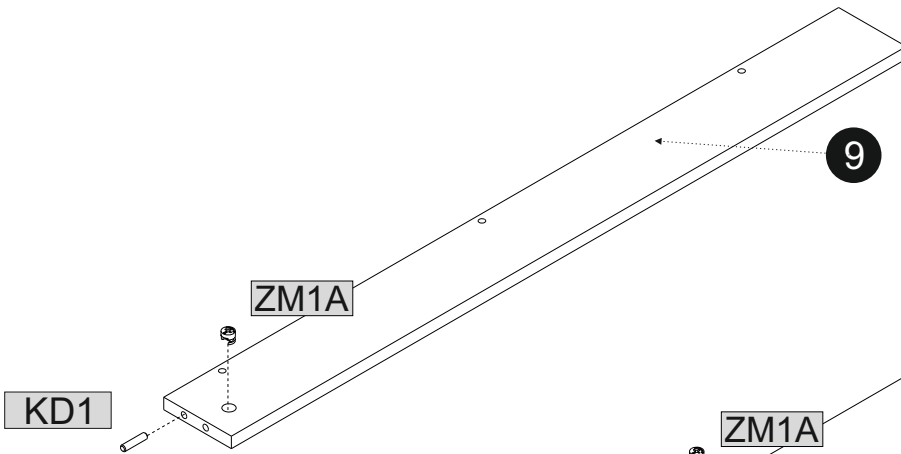
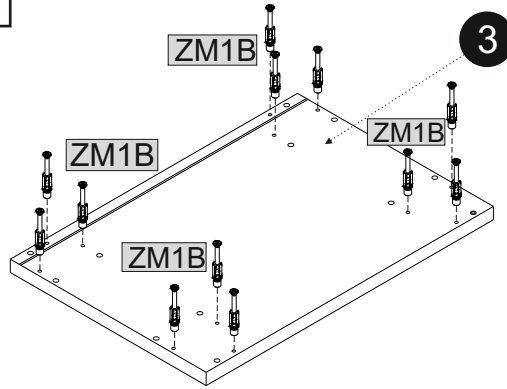

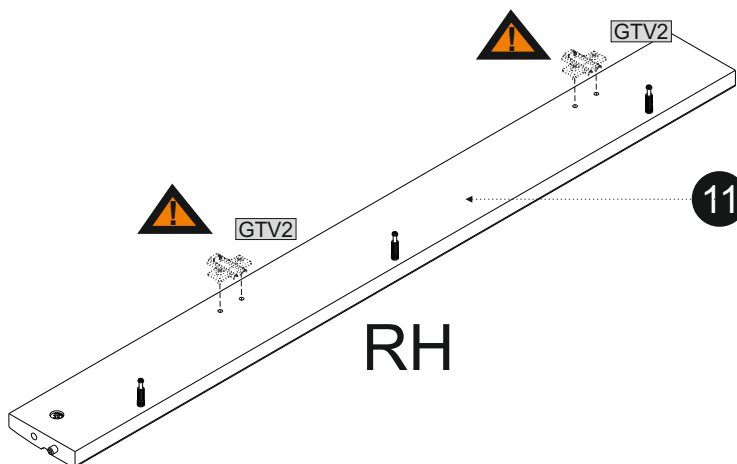
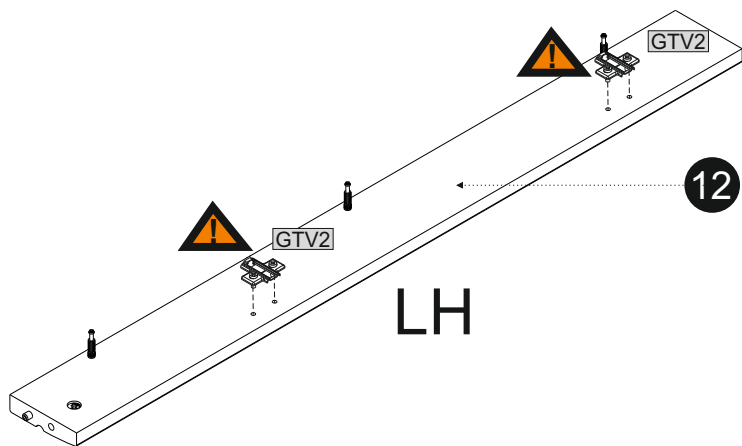
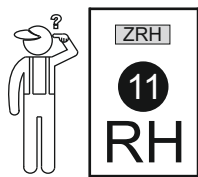
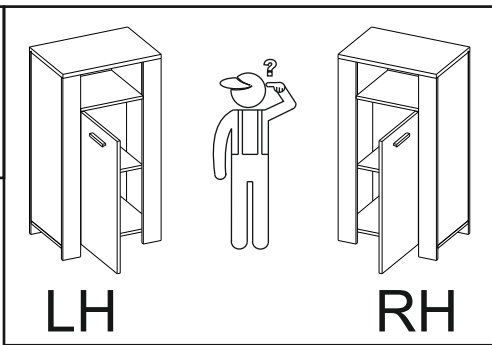
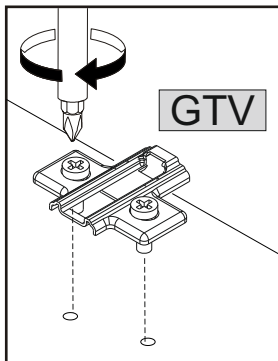
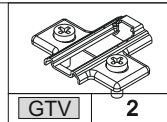
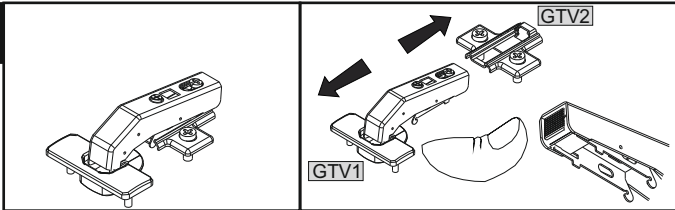

04

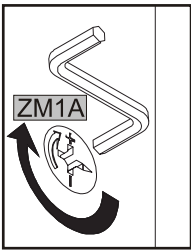

KK1	1

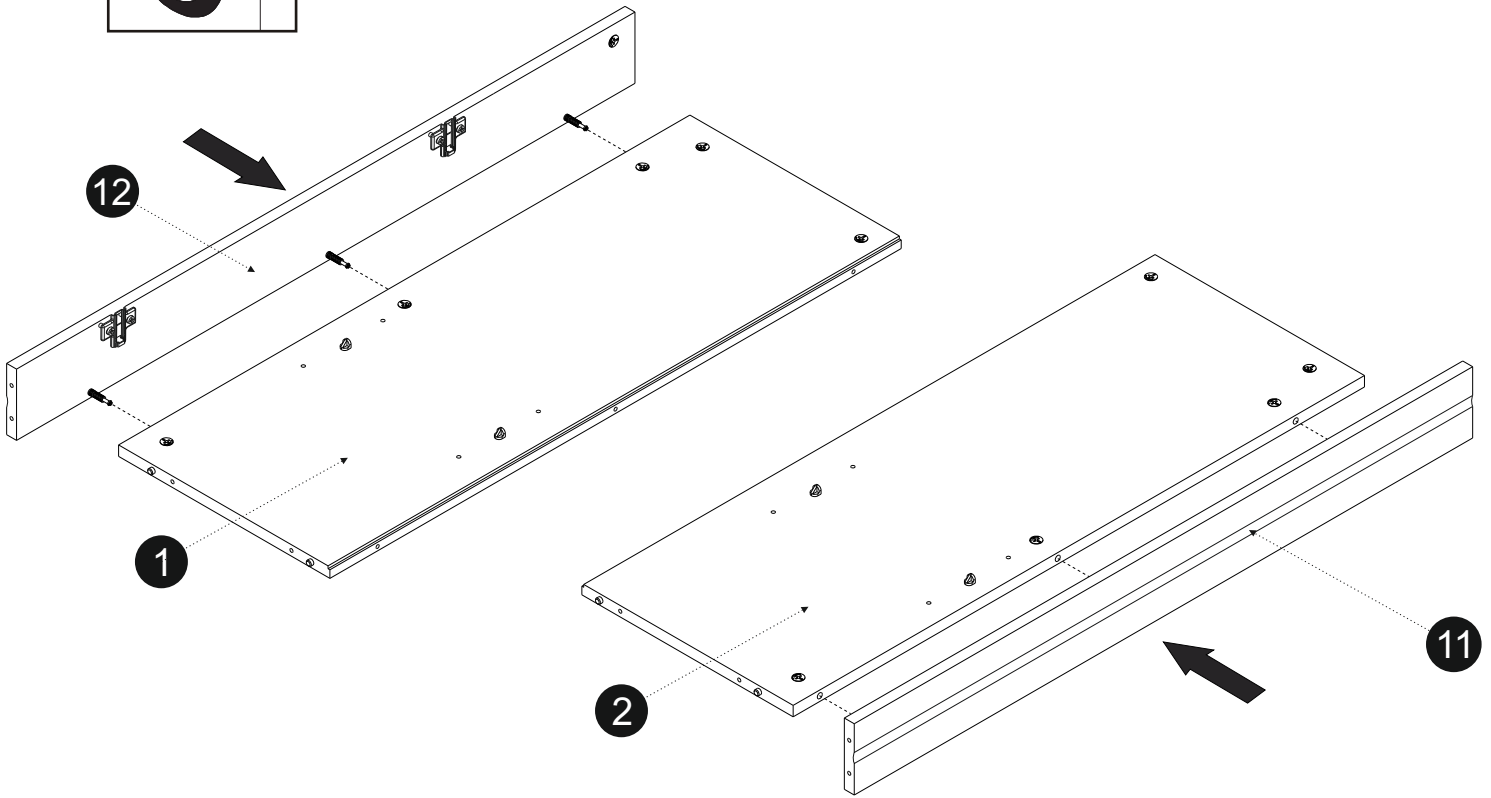

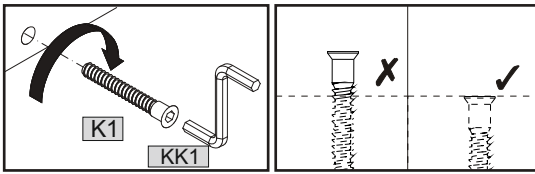
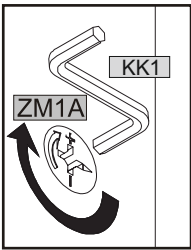

05

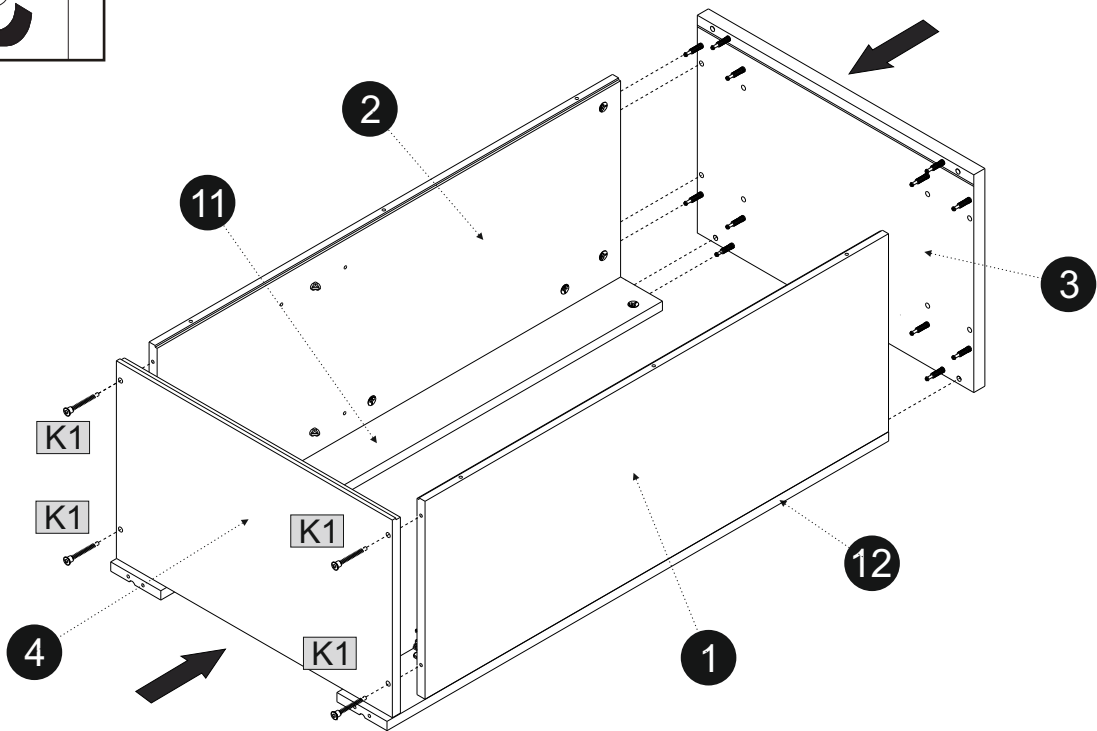

KK1	1	K1	4
		7x50	



			
KK1	1	K1	4

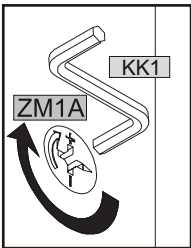
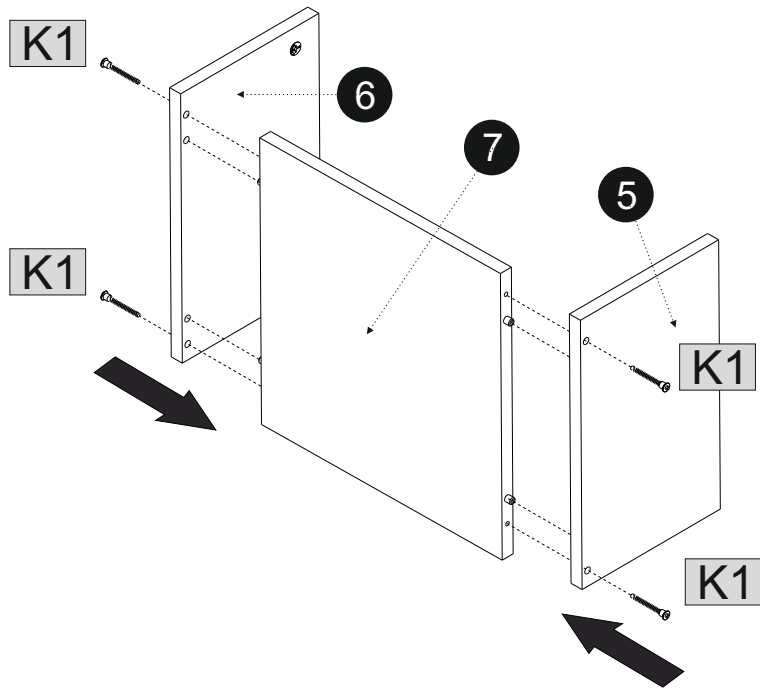

	
KK1	1

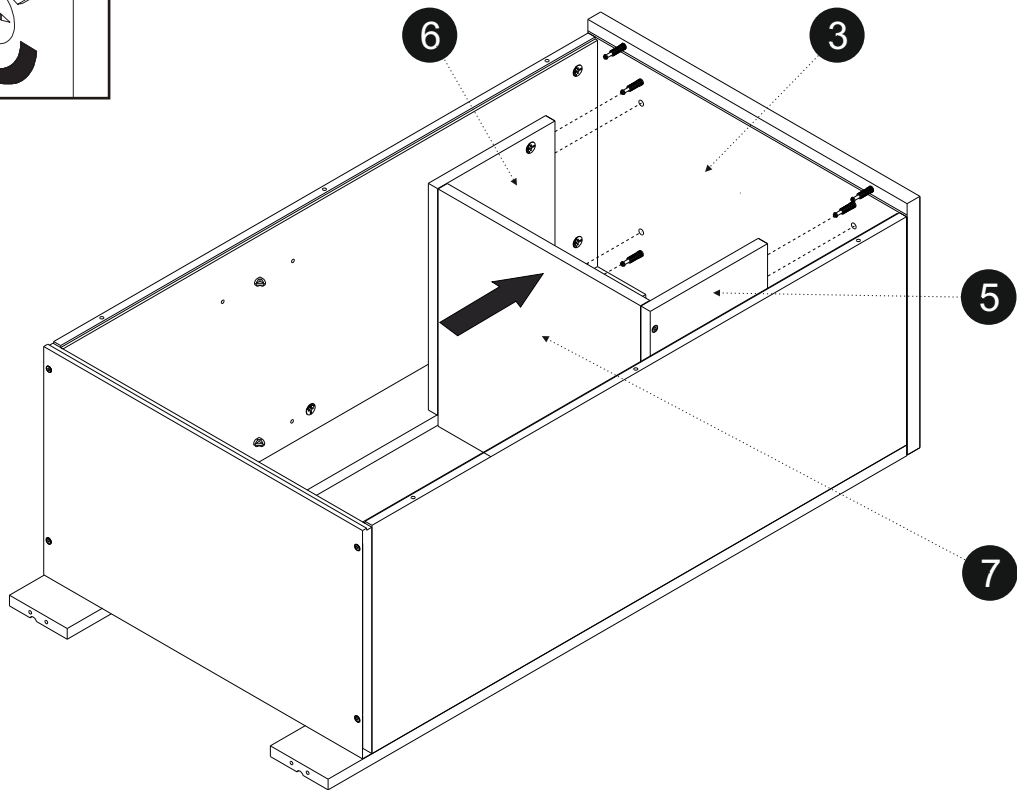

08

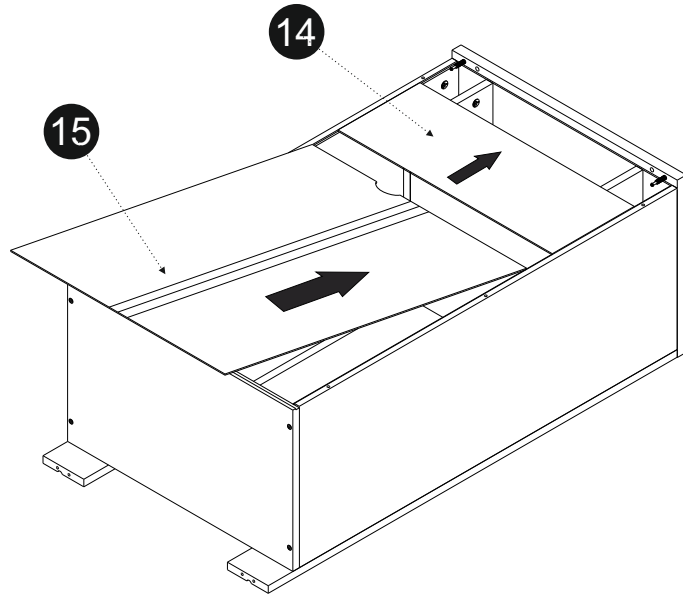
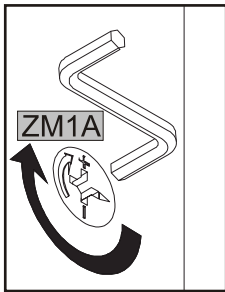



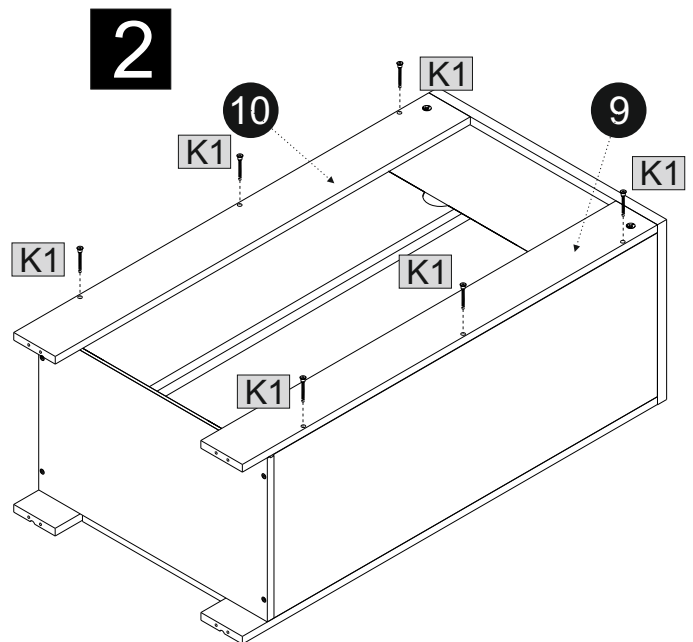
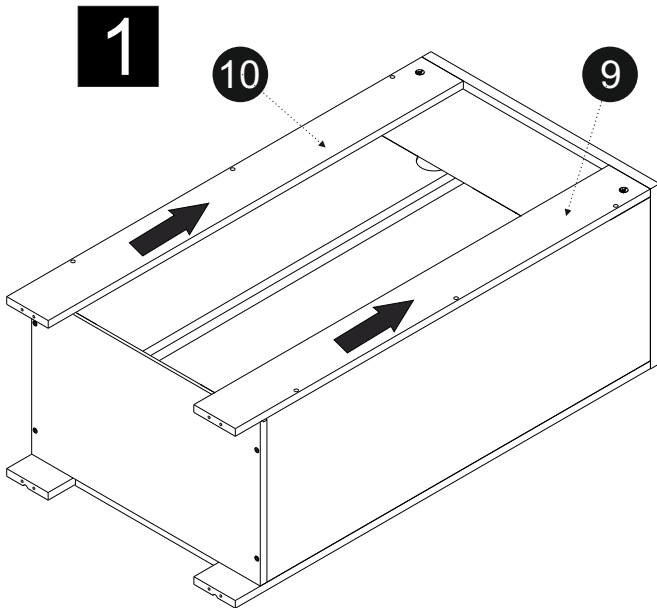

09

KK1	1	K1	6
		7x50	

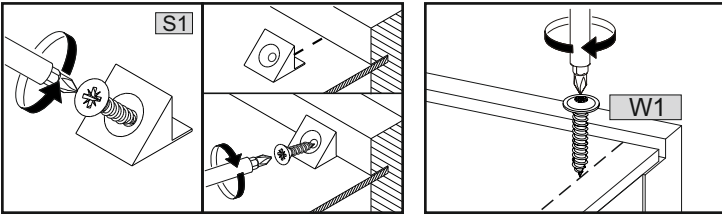

10



			3x16		
PL1	3	W1	6	S1	1

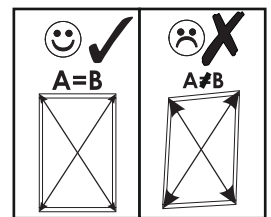
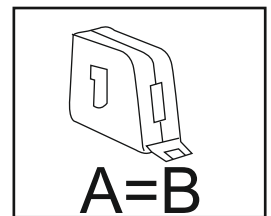
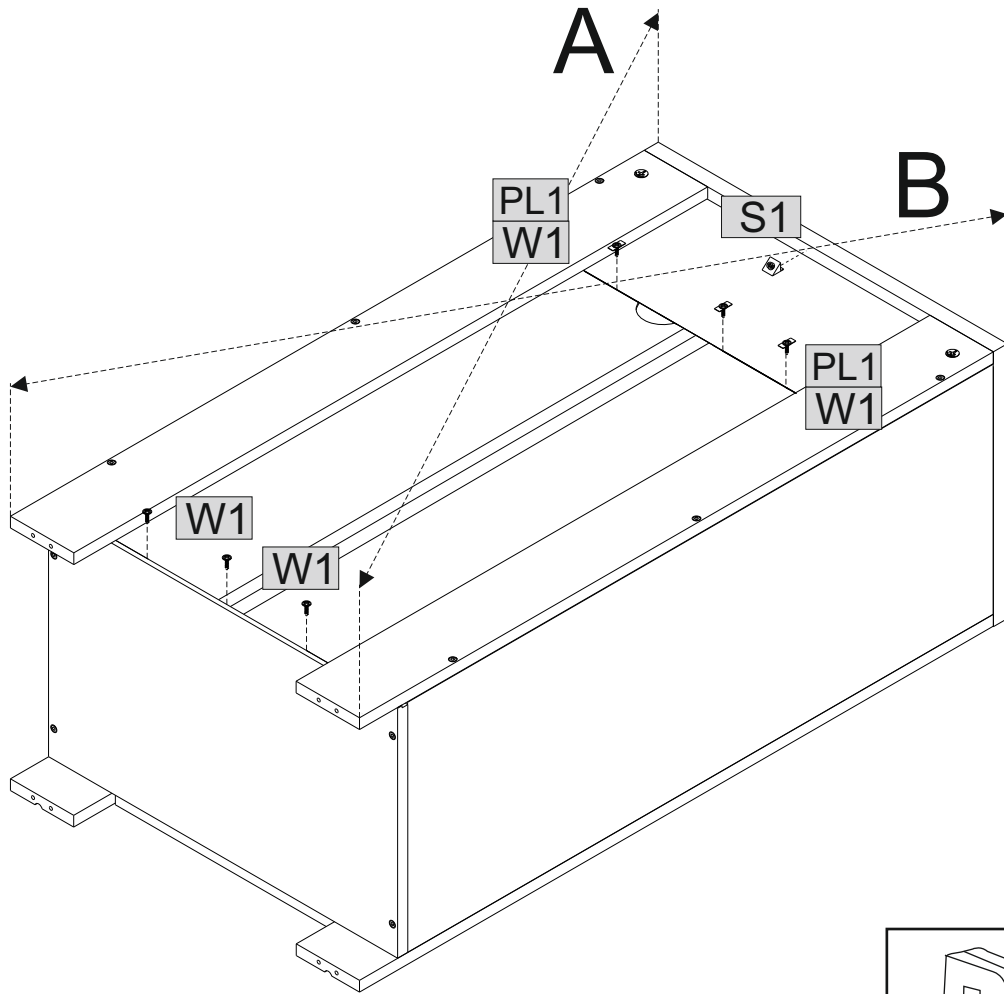
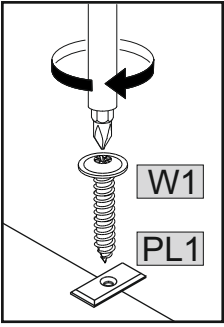

11

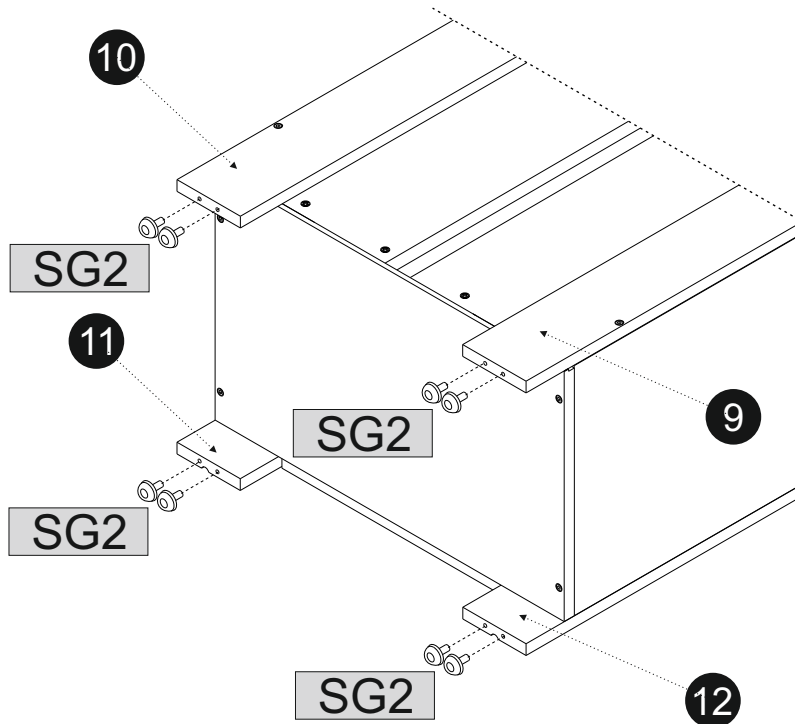
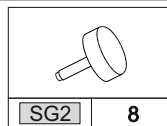
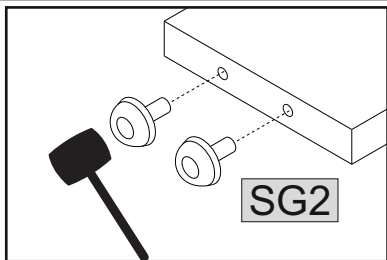

12

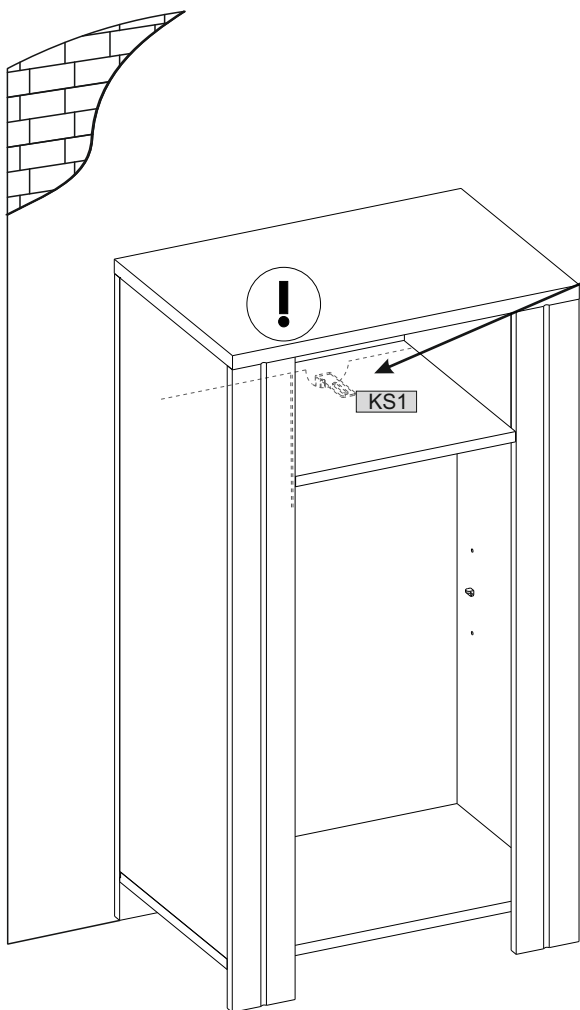

KRW1	W11	KS1
1	2	1

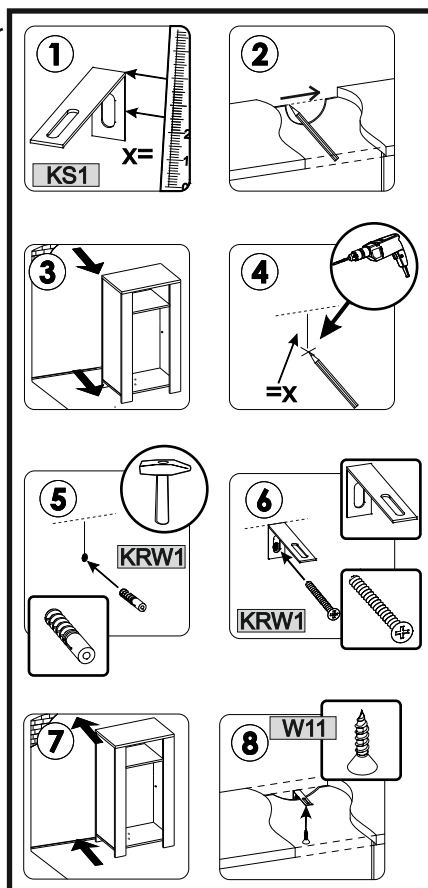

13

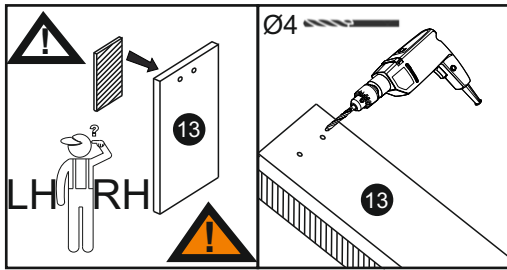

	2		4
GTV1		W4	

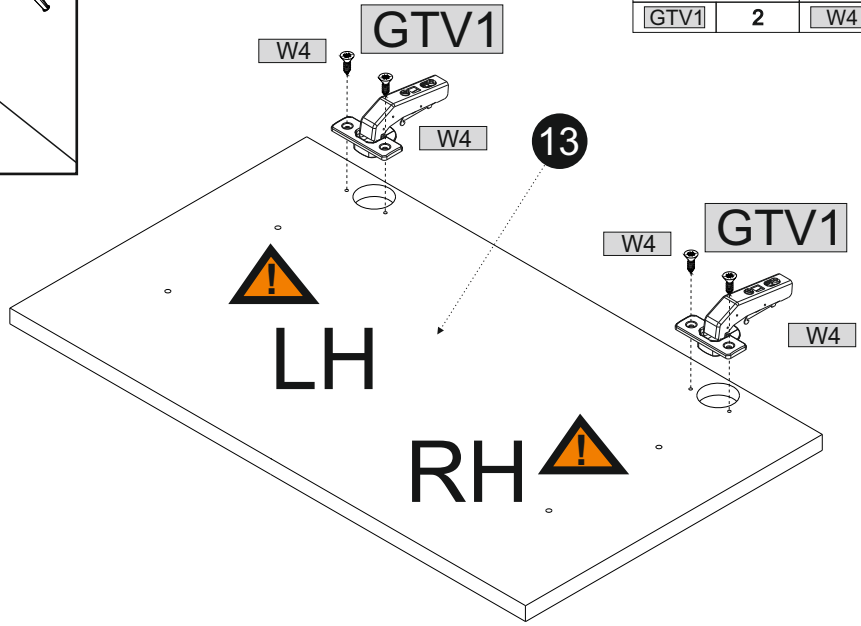
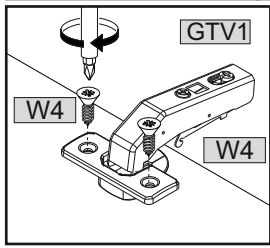

14

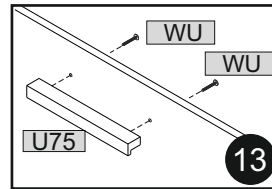
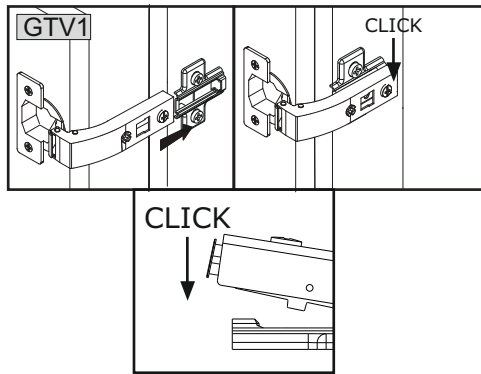

	1		2
U75		WU	

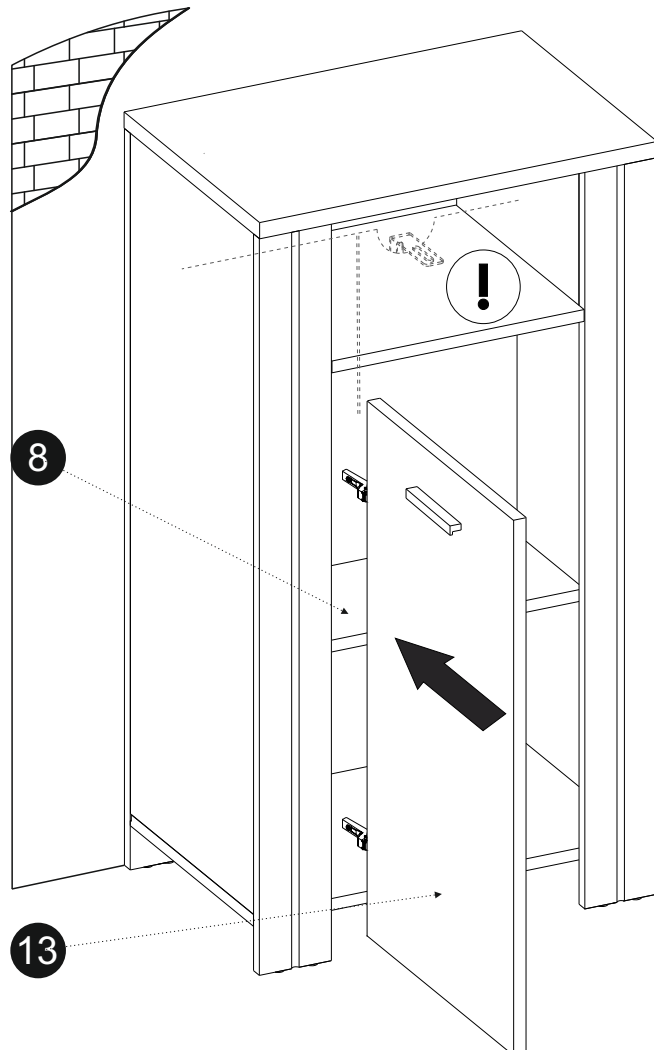
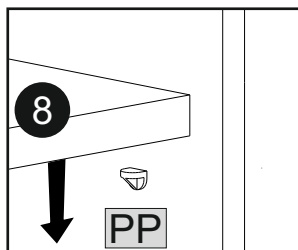

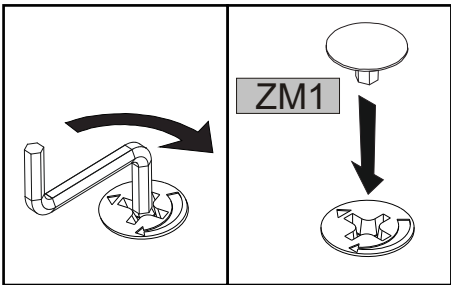

KK1	1	ZM1	8

