

# SLASH BIURKO

**MEBLE-OKMED**  
**DEMKO**

„MEBLE-OKMED” DEMKO - SPÓŁKA JAWNA  
ul. Kolejowa 13, 14-500 Braniewo, POLSKA  
[www.mebleokmed.pl](http://www.mebleokmed.pl) (+48) 55 243 27 26  
[firma@mebleokmed.pl](mailto:firma@mebleokmed.pl)

SERIA: .../...

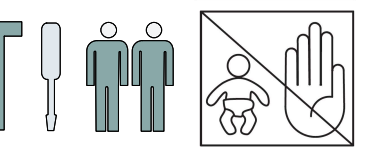
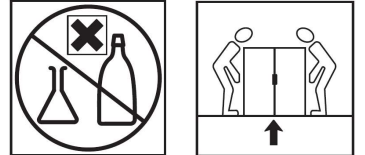
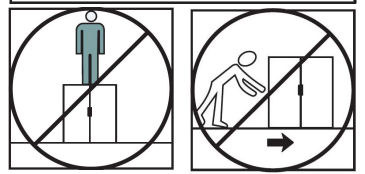
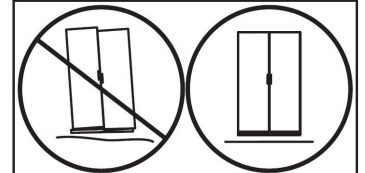
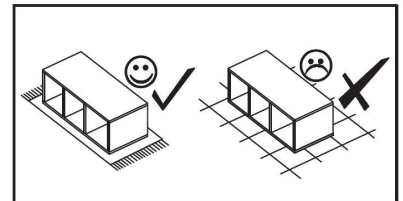
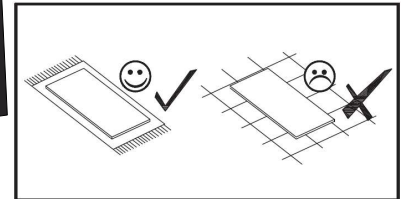
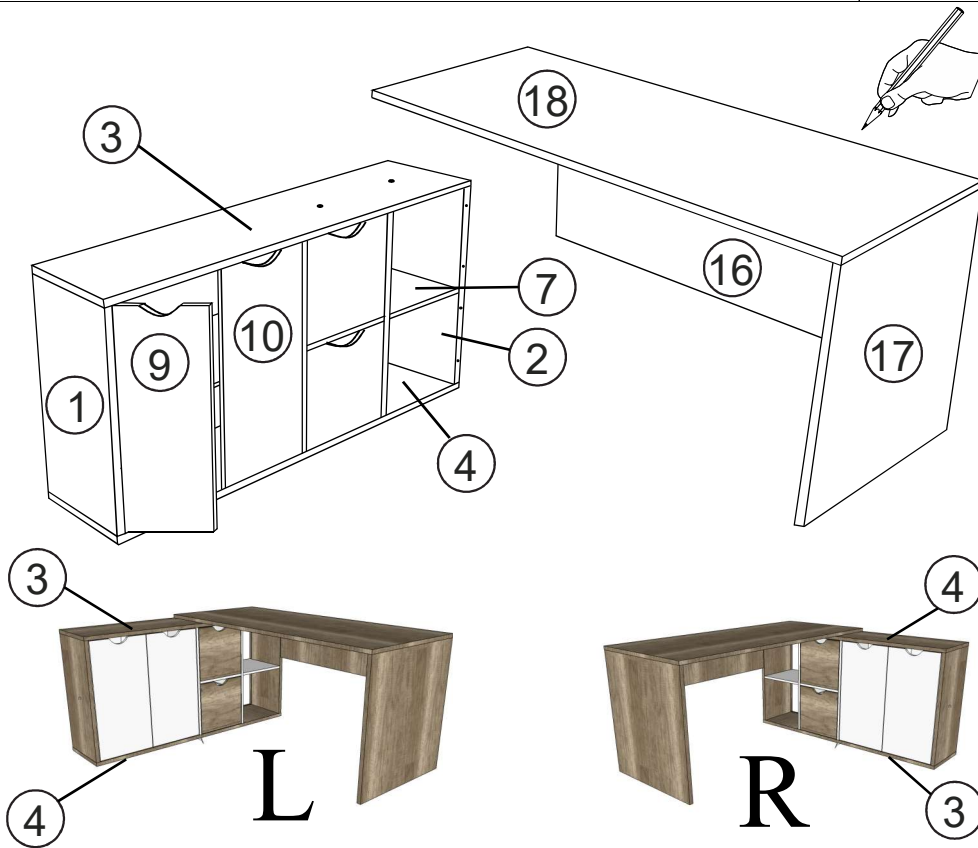
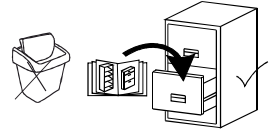

1/2	12	16x290x240	x4
	14	16x335x335	x2
	13	16x335x335	x2
	15	3x305x315	x2
	17	22x668x740	x1
	5	16x329x696	x1
	6	16x329x696	x1
	7	16x328x340	x2
	8	16x293x695	x1
	9	16x343x690	x1
	10	16x343x690	x1
11	3x706x708	x1	

2/2	18	22x1.600x670	x1
	16	22x1246x200	x1
	4	22x1.452x330	x1
	3	22x1.452x330	x1
	1	22x329x696	x1
	2	22x329x696	x1

Szafka Pokojowa  
**SLASH BIURKO**  
SERIA .../...  
Front: .....  
Korpus: .....  
**MEBLE-OKMED DEMKO**  
MEBLE OKMED Demko SP J.  
14-500 Braniewo, Ul. Kolejowa 13  
*Justujemy razem 30 lat!*

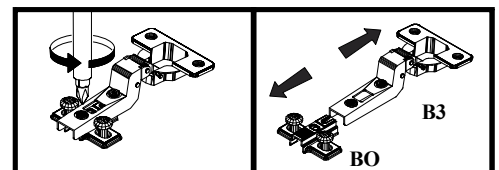
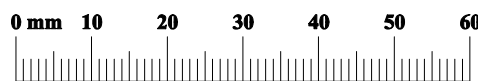
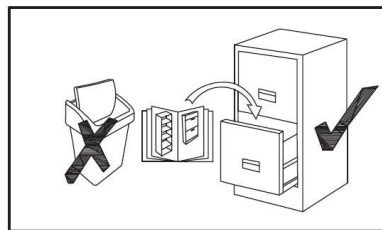

E1 35	E2 37	E3 37	E5 1	E7 2	D1 4	B3 4	NR 2
W4 8	W8 8	O1 1	K1 39	K2 2	B0 4	SP 6	

01

B0	4	K2	2	E5	1	D1	4	K1	4	E1	4	E2	20

2/4

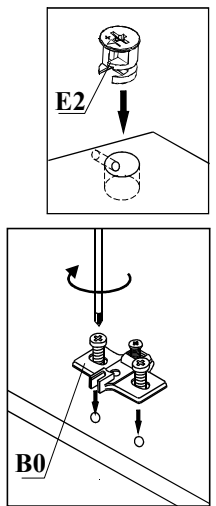
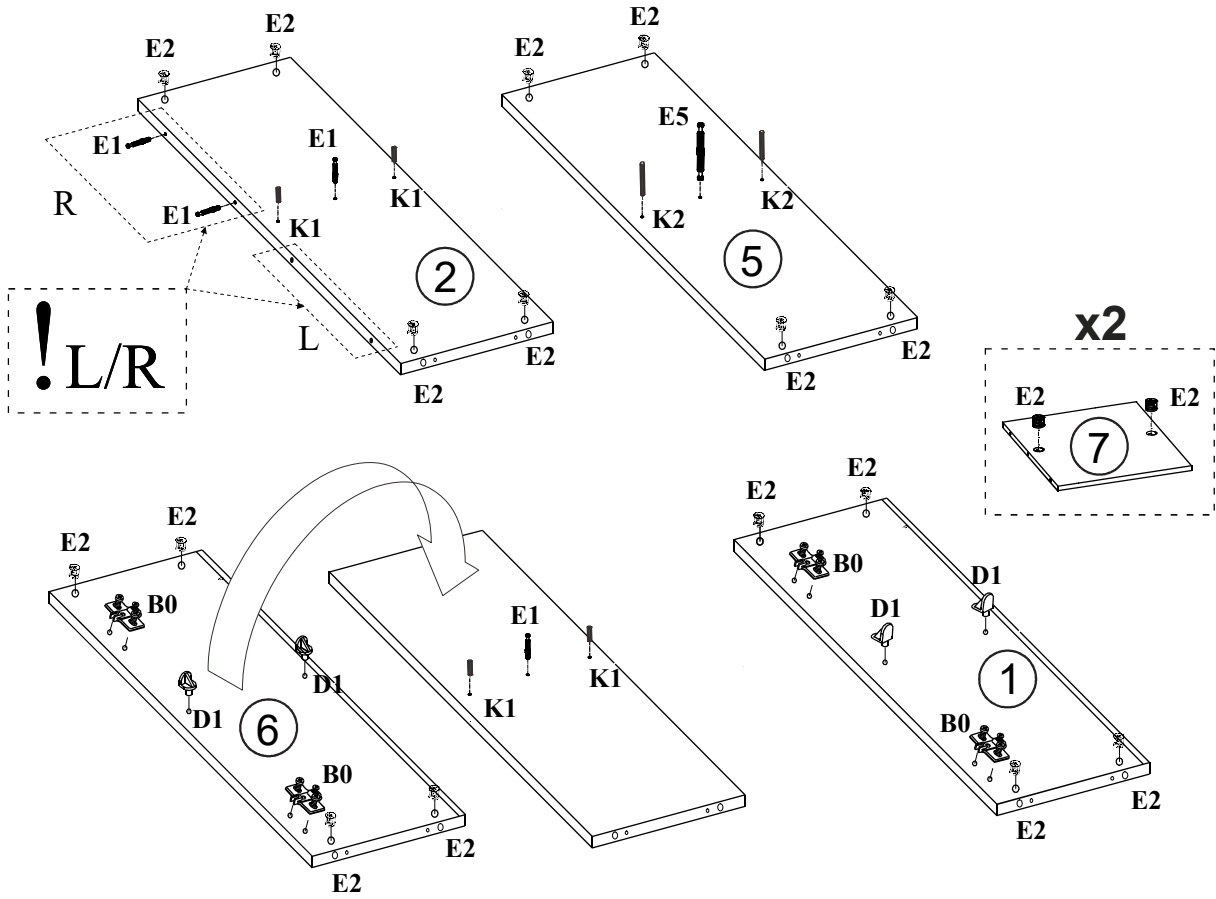

02

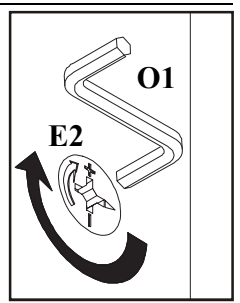
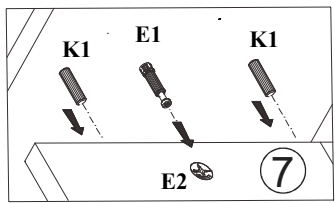
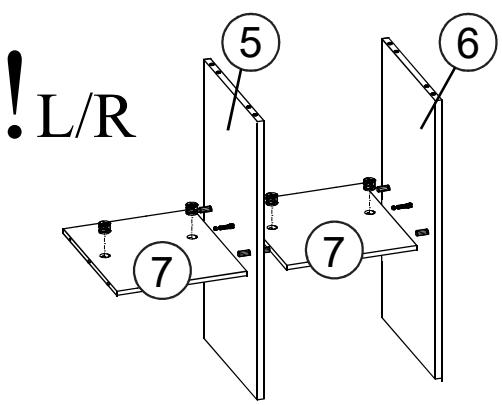



03

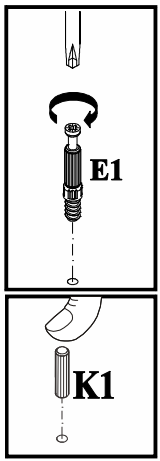
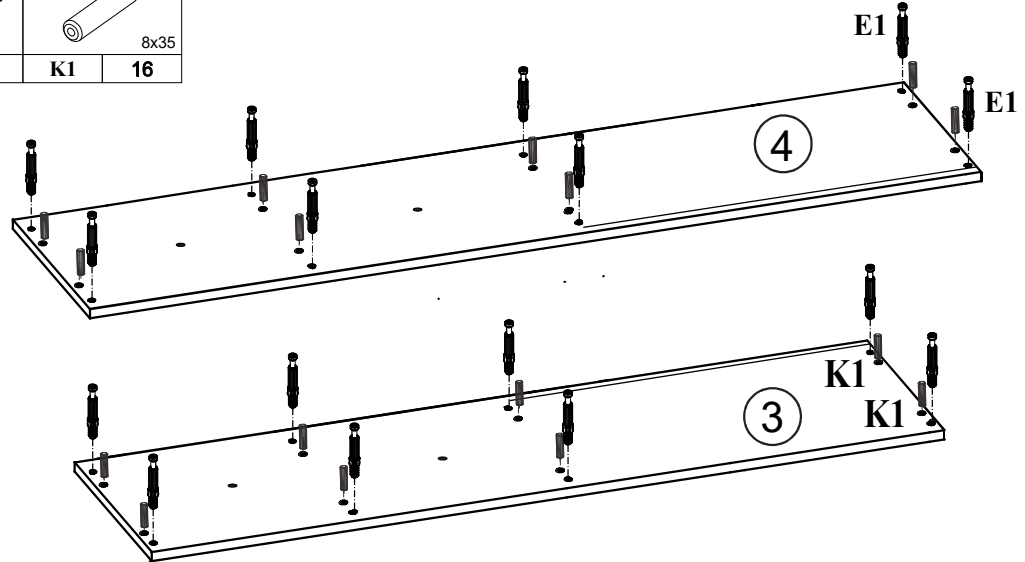

E1	16	K1	16

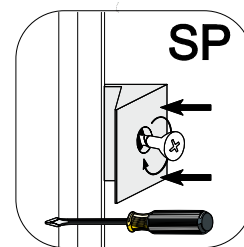
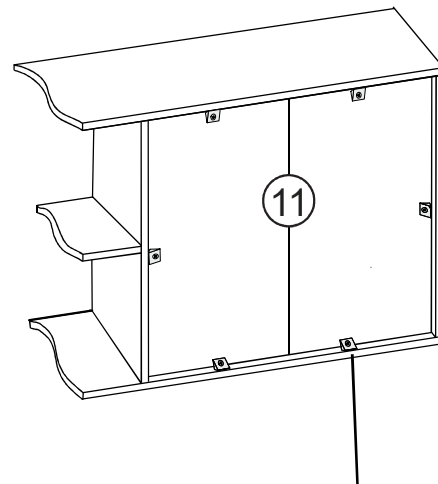
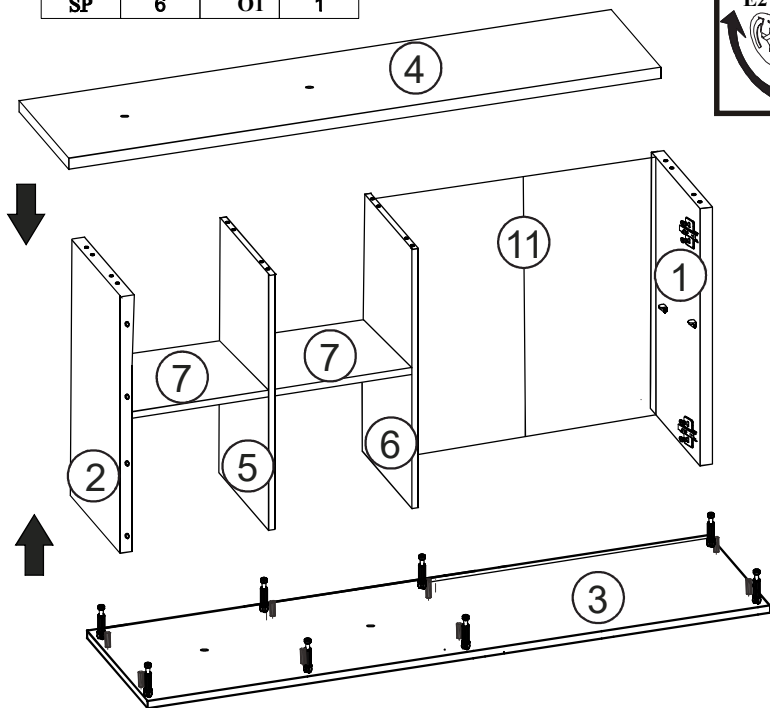
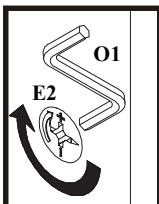

**04**

	
SP 6	O1 1

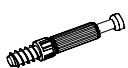
**3/4****05**



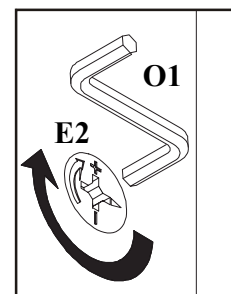
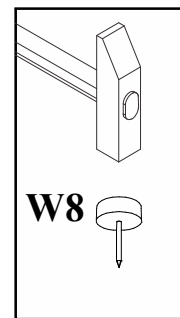
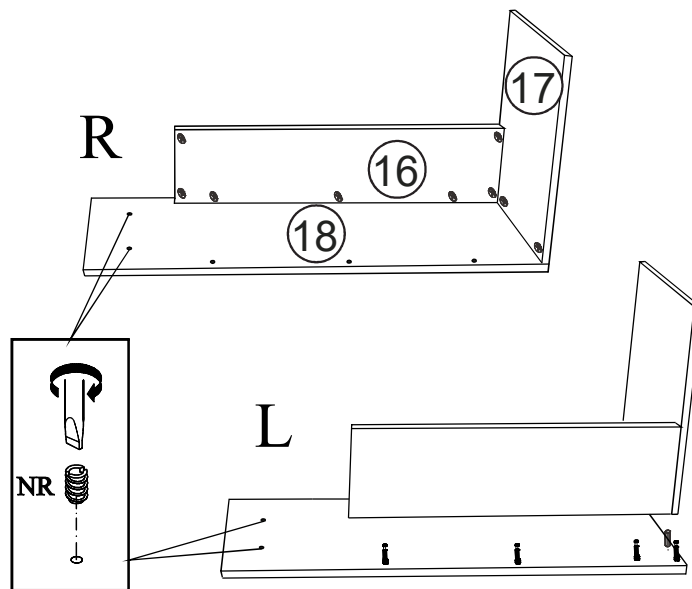
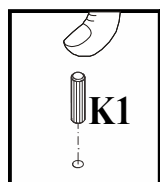
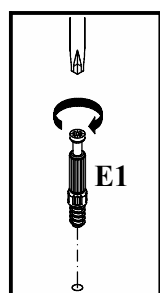
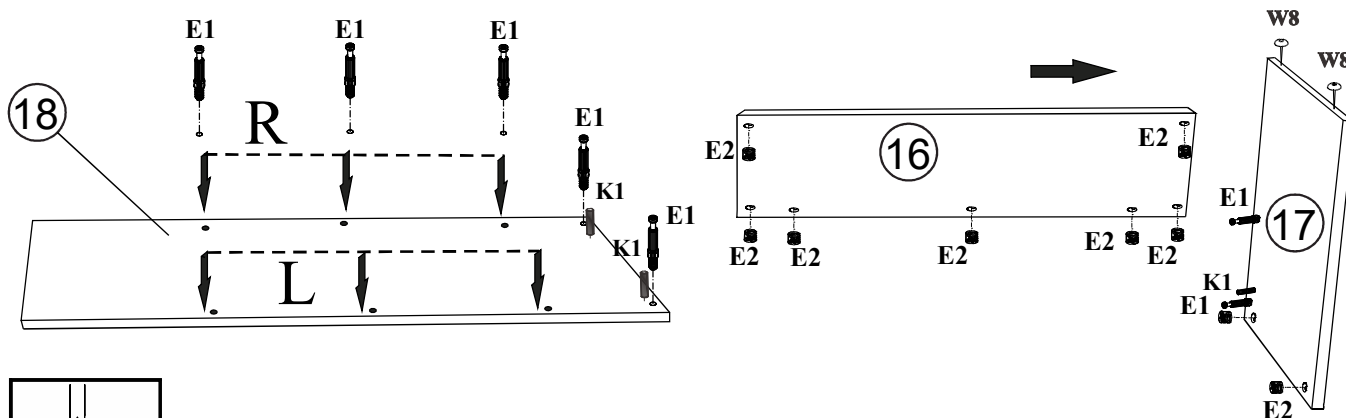

					
E1 7	K1 4	E2 9	W8 2	NR 2	O1 1



06

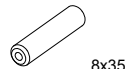

4/4

x2

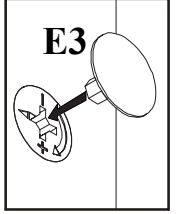
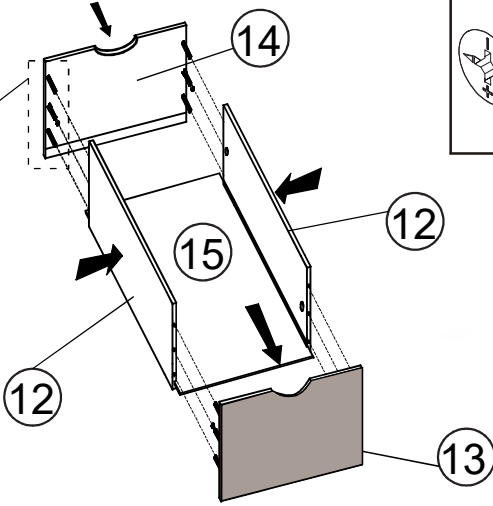
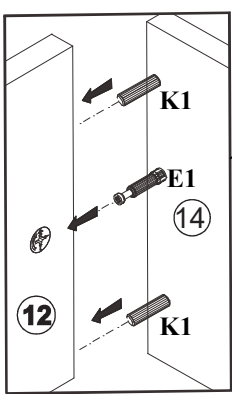
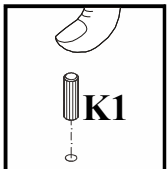
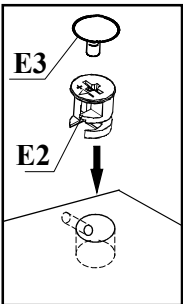
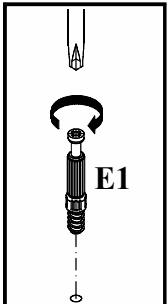
									
E1	4	K1	8	O1	1	E3	4	E2	4





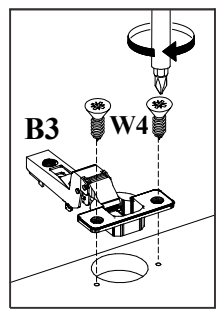
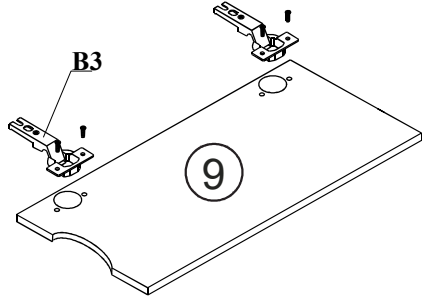
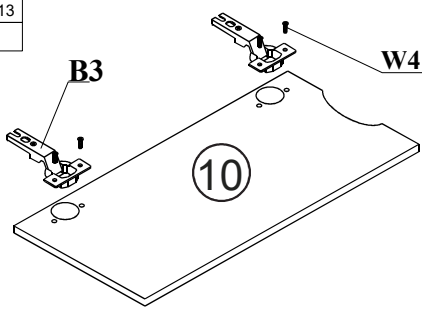

07

			
B3	4	W4	8



08

							
E7	2	O1	1	E3	29	W8	6

