

[PL] Notatki ogólne

Montaż mebli kuchennych powinien być wykonywany tylko przez osoby wykwalifikowane. Przed instalacją należy zapoznać się z instrukcją montażu. Istnieją specjalne, bardziej szczegółowe instrukcje montażu i informacje dotyczące urządzeń, zmywarek, piekarników, oświetlenia i wyposażenia specjalnego, które również należy przestrzegać.

Podczas montażu elementów ściennych należy przestrzegać następujących zasad:

- Jeśli elementy do zamocowania nie zostały dostarczone lub są nieodpowiednie do właściwości występujących ścian. Należy skontaktować się z lokalnym sprzedawcą, aby uzyskać odpowiednie kołki rozporowe / haki / szyny do zawieszania / śruby / wkręty.

No. 1 No. 2

- Do mocowania na ścianie należy używać haczyków lub szyn.

- Szafki podwieszane mogą wytrzymać obciążenie ok. 40 kg w przypadku prawidłowego zainstalowania. Upewnij się, że ładunek jest równomiernie rozłożony.

Jeśli instrukcje nie są przestrzegane, a szafka jest zamontowana nieprawidłowo, nie ponosimy odpowiedzialności za szkody wynikłe z niewłaściwego montażu.

Pamiętaj, aby odpowiednio ustawić i powiesić szafki lub cały zestaw kuchenny, w taki sposób, aby zabezpieczyć go przed przewróceniem.

Instalacje wodne i elektryczne mogą być wykonywane tylko przez wykwalifikowanego specjalistę.

No. 3

Przed wierceniem należy się upewnić, że w ścianie nie przebiegają żadne kable prądowe / rury gazowe, wodne, ogrzewania itp.

Przed instalacją sprawdź, czy wszystkie połączenia są prawidłowe i zostały wykonane profesjonalnie.

Kuchnia zawiera małe części, które mogą powodować niedrożność / zadławienie. Nie zostawiaj dzieci poniżej 3 lat bez opieki.

Zalecana kolejność montażu mebli kuchennych:

Zaplanuj dokładną lokalizację szafek kuchennych, biorąc pod uwagę podłączenie wody i elektryczności. Sprawdź, czy lodówka / zamrażarka wymaga wylotów powietrza w podstawie lub na powierzchni.

No. 4

Zakup w specjalistycznym sklepie odpowiednie kratki wentylacyjne jeśli nie są dołączone i wytnij otwory w podłożu lub/i blacie zgodnie z instrukcją producenta urządzenia. Zdecyduj, czy drzwi będą się otwierać w prawo lub w lewo.

No. 5

Najpierw zainstaluj szafki wiszące. Dokładnie wyznacz położenie otworów montażowych. Wywierć i zamontuj elementy mocowania (haki/ listwa montażowa). Zamontuj szafki i wyrównaj ich poziom przy użyciu poziomicy. Połącz poszczególne szafki za pomocą śrub. Dla ułatwienia, zalecamy stosowanie dwóch ścisków śrubowych. Ustaw, ściśnij i skręć.

No. 6

Ustaw szafki dolne, wyrównaj poziom i połącz ze sobą podobnie jak w szafkach wiszących.

Umieść blat na szafkach, wyrównaj go. Zaznacz położenie i szerokość szafki do zabudowy piekarnika i zlewu.

No. 7

Na spodniej stronie blatu za pomocą szablonów dołączonych do urządzeń wyznacz miejsca otworów do wycięcia. Szablony ustaw w taki sposób, aby zlew znajdował się w środku szafki, a szerokość panelu pozostała taka sama z przodu i z tyłu.

No. 8

Wywierć otwór o średnicy 10 mm w każdym z czterech narożników zaznaczonego obszaru, aby ułatwić włożenie wyżynarki a następnie wyciąć

wzdłuż oznakowania. Zawsze pracuj na spodniej części blatu, tak aby piła nie uszkodziła powierzchni zewnętrznej blatu.

No. 9

Powierzchnie cięte powinny być zabezpieczone przed nasiąkaniem wilgocią.

Miejsce styku blatu ze ścianą uszczelnij za pomocą silikonu lub listwy przyblatowej.

No. 10**[EN] General notes**

The assembly of kitchen furniture should only be carried out by qualified staff. Before starting the installation, read the assembly instructions. There are special, more detailed installation instructions and information about appliances, dishwashers, ovens, lighting and special equipment that also need to be followed.

When mounting wall components, the following rules must be followed:

- If the fastening elements are not supplied or are not suitable for the properties of the existing walls, please contact your local retailer to obtain the appropriate wall studs / hooks / suspension rails / screws / bolts.

No. 1 No. 2

- Use hooks or rails for wall mounting.

- Hanging cabinets can withstand a load of approx. 40 kg if they have been installed properly. Make sure that the load is equally distributed.

If the instructions are not followed and the cabinet is installed incorrectly, we are not liable for damages resulting from incorrect assembly.

Remember to set up and hang cabinets or the entire kitchen set in such a way as to prevent it from tipping over.

No. 3

Water and electrical installations may only be carried out by a qualified specialist.

Before drilling, make sure that there are no electricity wires / gas pipes, water pipes, heating, etc. in the wall.

Before installation, check that all connections are correct and have been made professionally.

The kitchen set contains small parts that can cause obstruction / choking. Do not leave children under 3 years of age unattended.

Recommended order of assembly kitchen furniture:

Plan the exact location of your kitchen cabinets, taking into account the water and electricity supply.

No. 4

Check that the fridge/freezer requires air outlets in the base or on the surface.

Purchase the appropriate ventilation grilles from a specialist shop if not included and cut out the holes in the base and/or worktop according to the manufacturer's instructions. Decide whether the door will open to the right or left.

No. 5

First install the hanging cabinets. Determine the exact position of the mounting holes. Drill and install the fastening elements (hooks / mounting rails). Mount the cabinets and level them using a spirit level. Connect the individual cabinets with screws. For ease of reference, we recommend using two screw clamps. Set, tighten and twist.

No. 6

Position the bottom cabinets, level the level and connect them like in the wall cabinets.

No. 7

Place the worktop on the cabinets, align it. Mark the position and width of the built-in oven and sink cabinet.

On the underside of the worktop, use the templates provided with the devices to mark out the holes to be cut out. Set the templates so that the sink is in the middle of the cabinet and the width of the panel remains the same at the front and back.

No. 8

Drill a 10 mm diameter hole in each of the four corners of the marked area to make it easier to insert the cutter and then cut it out along the marking. Always work on the underside of the worktop so that the saw does not damage the outer surface of the worktop.

The cut surfaces should be protected against moisture absorption.

No. 9

Seal the area of contact between the worktop and the wall with silicone or a skirting board.

No. 10

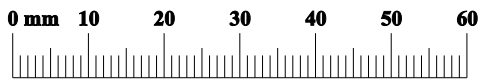
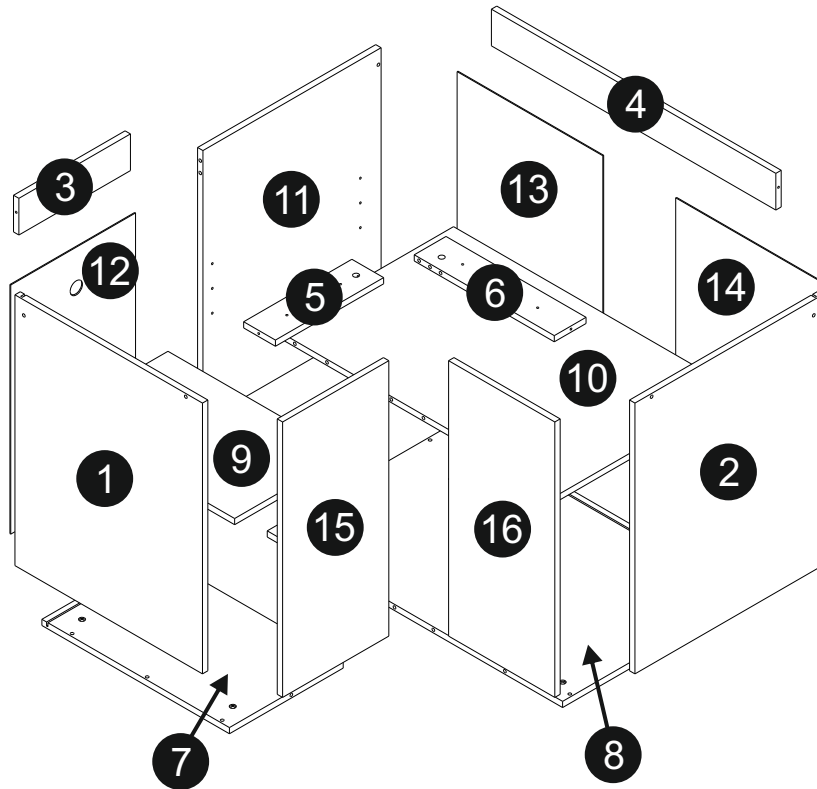
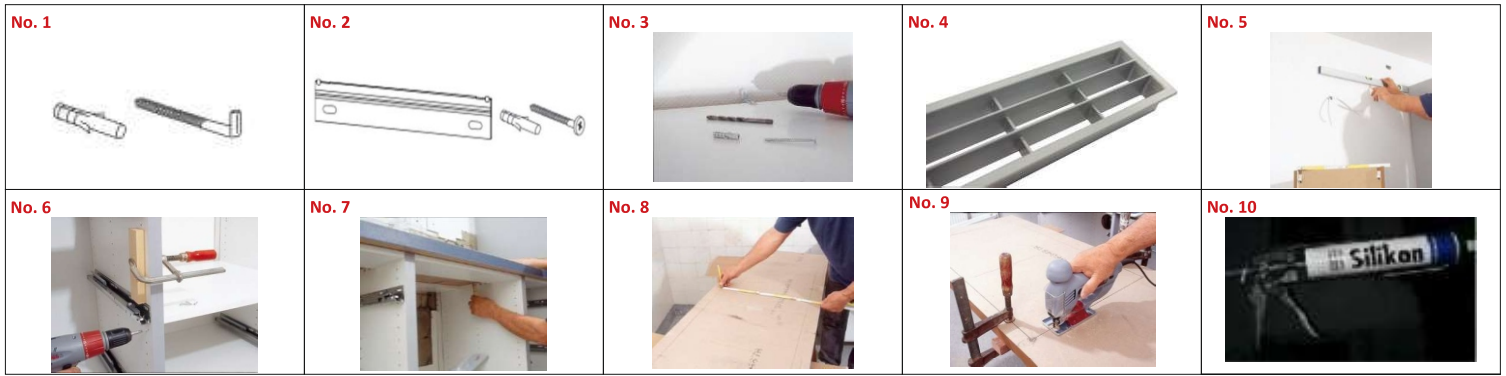

SR5 7	ZM1A 12	ZM1 9	ZK 4
4x30 4	4x13 8	3x16 27	3,5x25 2
W7 4	W4 8	W1 27	WU 2
TPP3 6	PP 6	NA1 7	NA1 7
7x50 14	KK1 1	AM2 2	ZRP1 4
WK1 1	U75 1	8x60 9	3,5x16 28
L=605mm 1	S1 7		

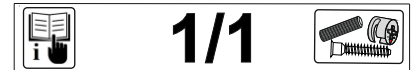

1/1

	B	H	T	
1	700	560	16	x1
2	700	560	16	x1
3	333	95	16	x1
4	849	95	16	x1
5	323	95	16	x1
6	418	95	16	x1
7	560	340	16	x1
8	882	560	16	x1
9	333	532	16	x1
10	849	532	16	x1
11	700	532	16	x1
12	644	373	3	x1
13	644	435	3	x1
14	644	435	3	x1
15	713	318	16	x1
16	713	318	16	x1

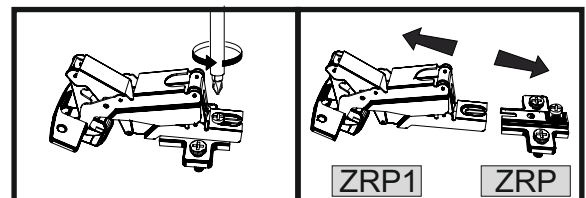
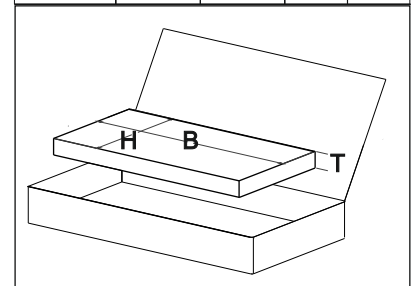

01

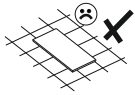
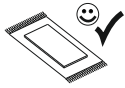

ZRP

4

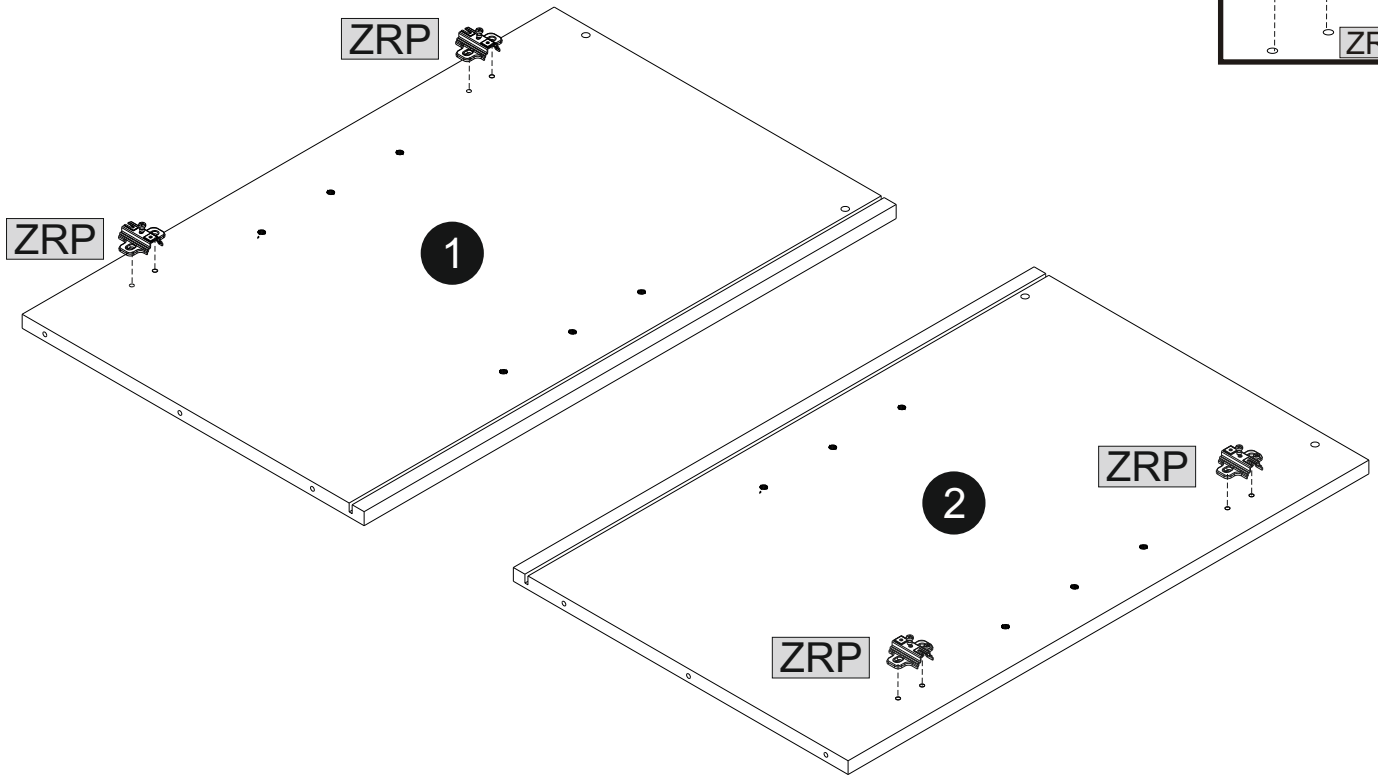
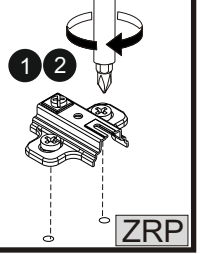

02

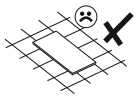
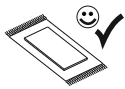

ZM1A

12

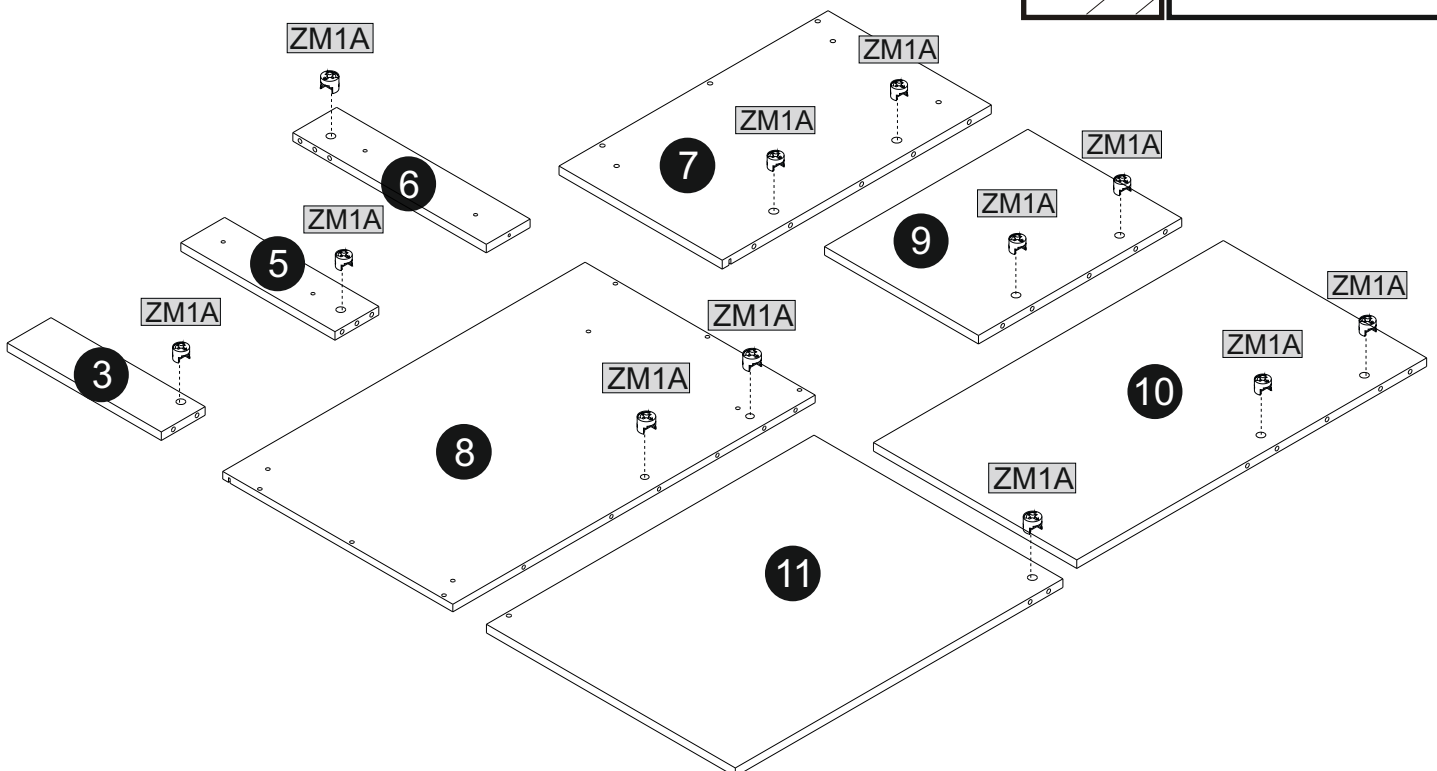
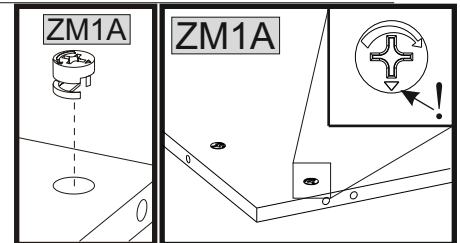

03

KK1	1	TPP2	6	KD2
				8x60

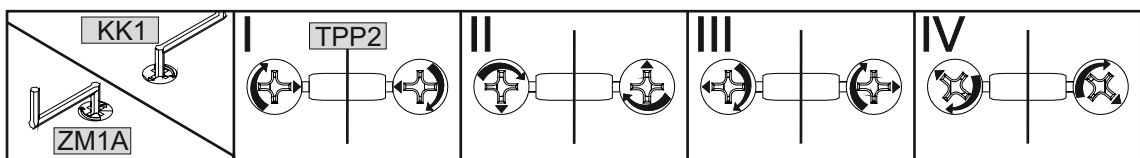
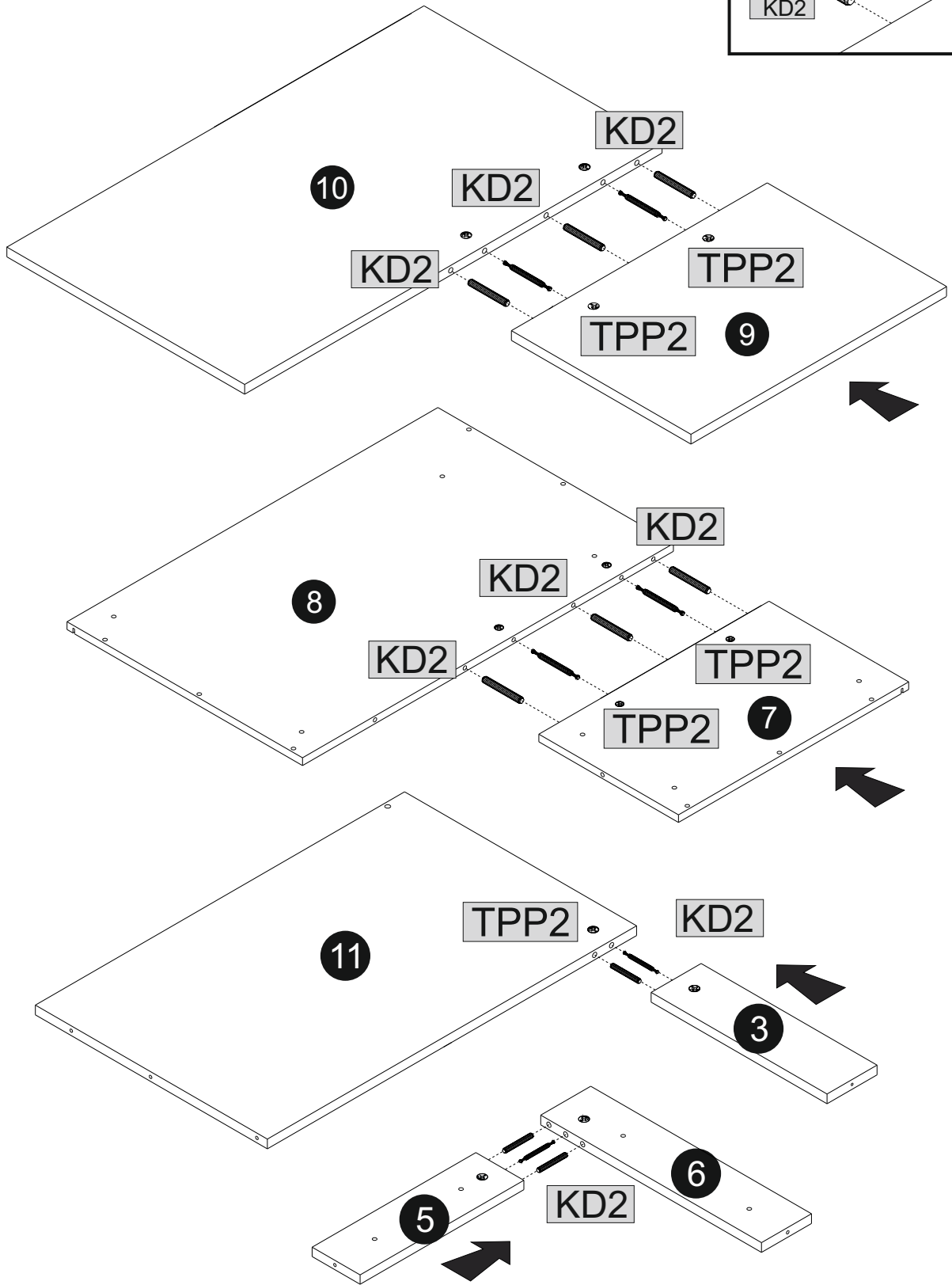
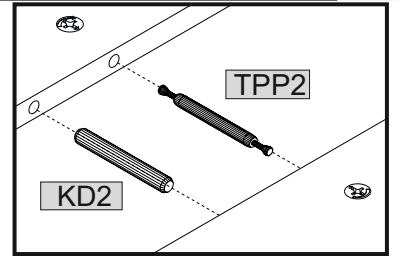

04

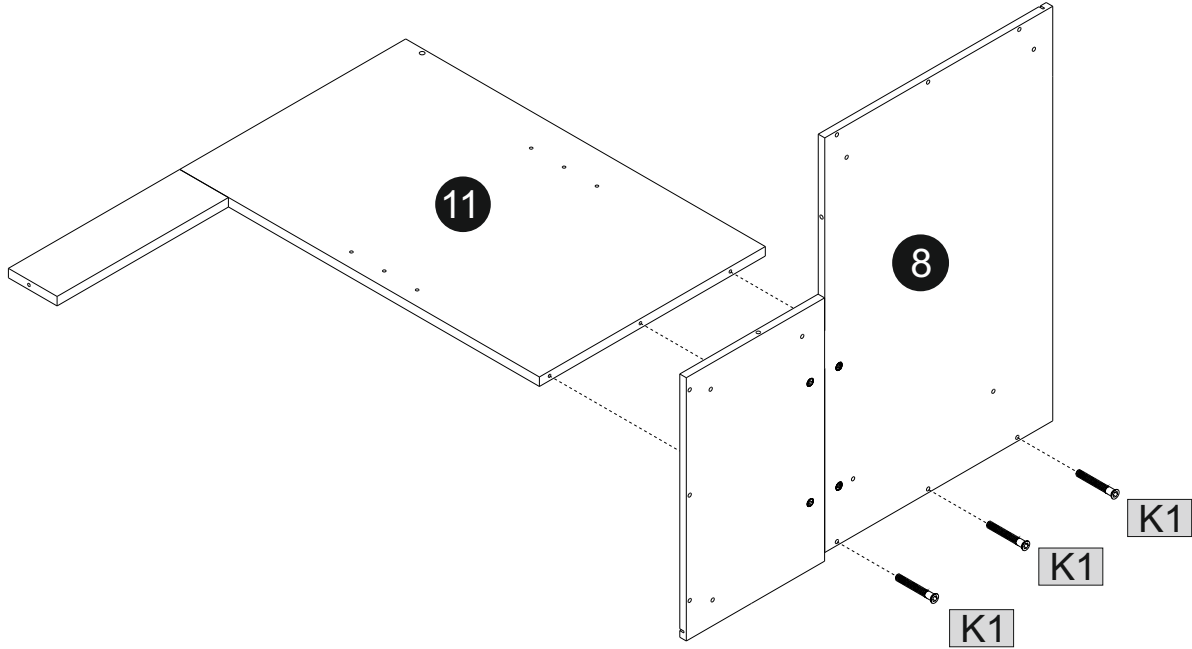
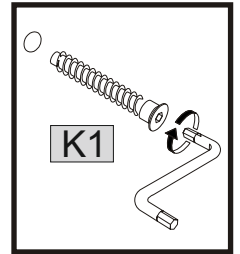
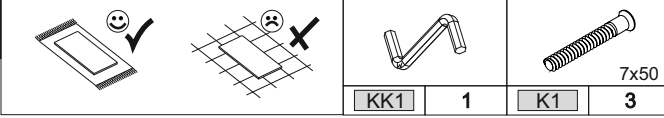

05

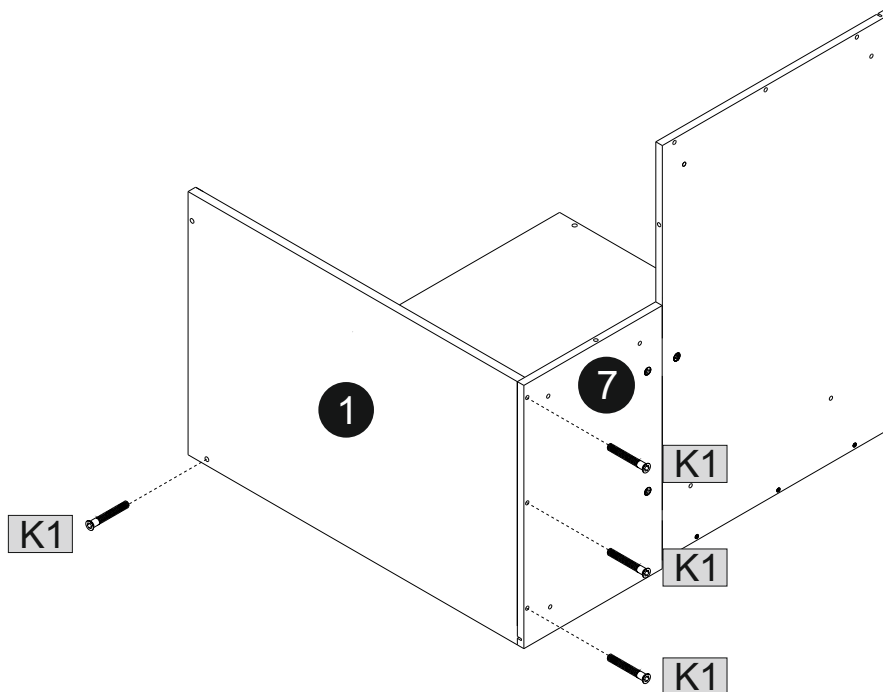
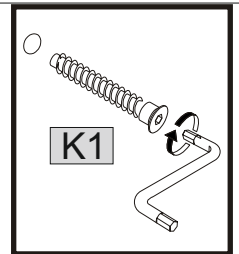
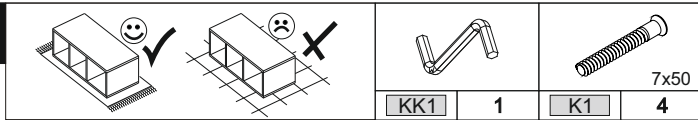

06

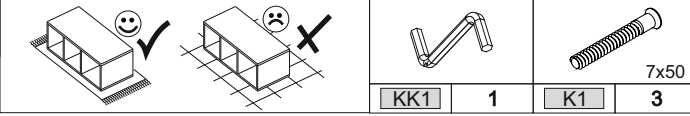

KK1	1	K1	3

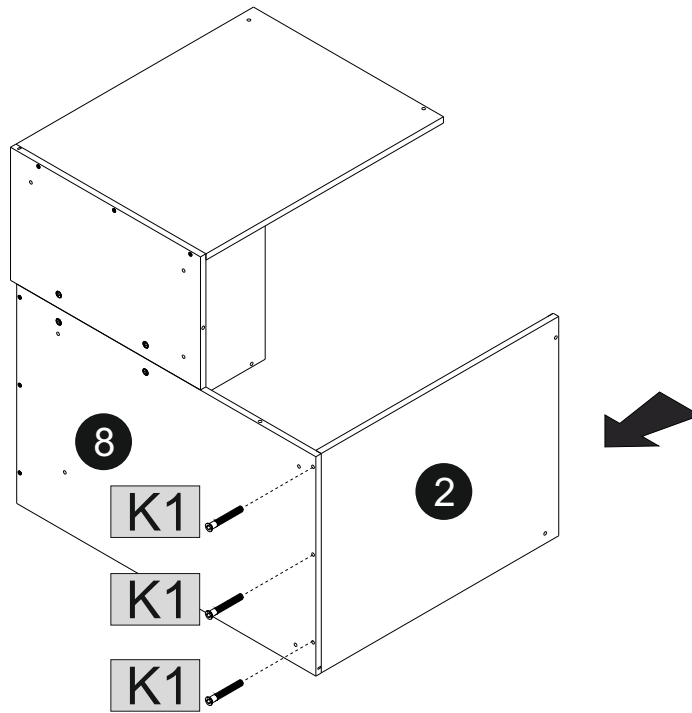
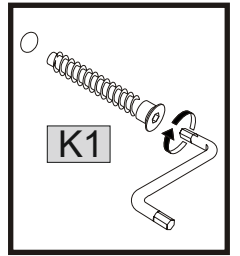

07

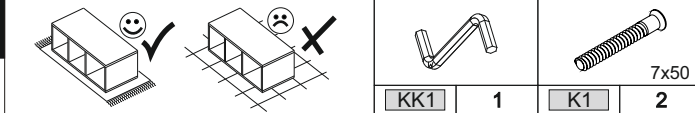

KK1	1	K1	2

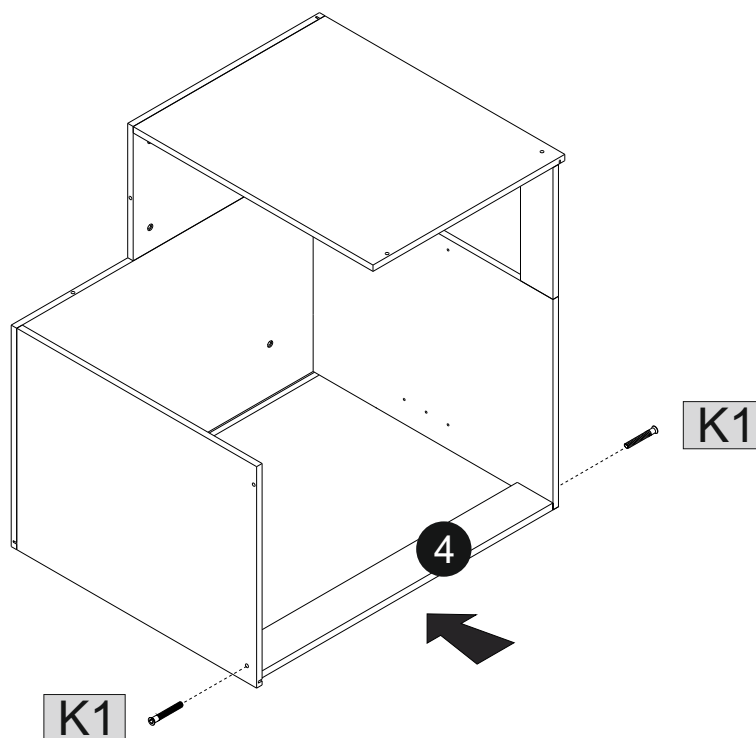
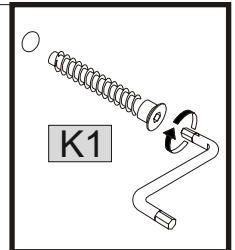

08

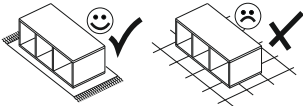

KK1	1	NA1	7	SR5	7	W11	28	NA1	7

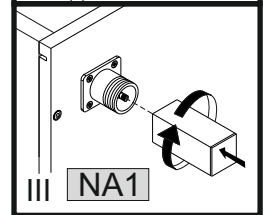
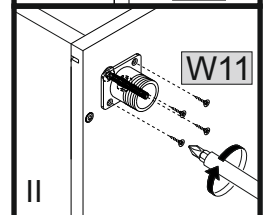
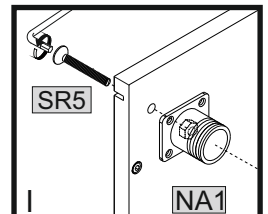
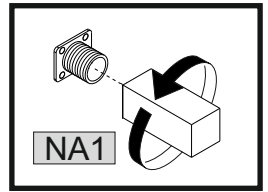
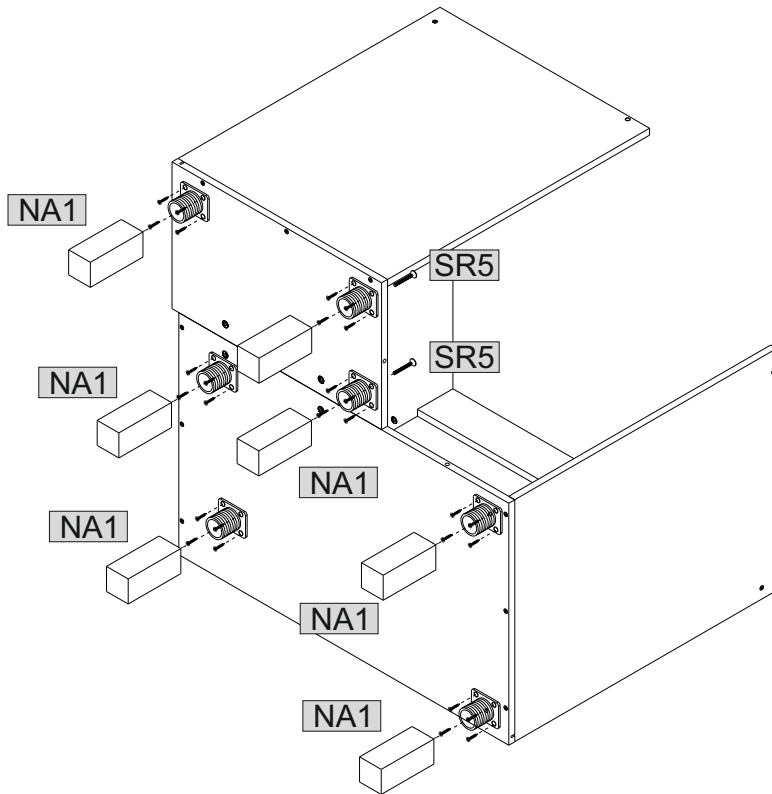

09

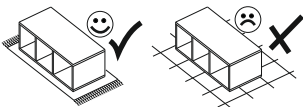

KK1	1	K1	2

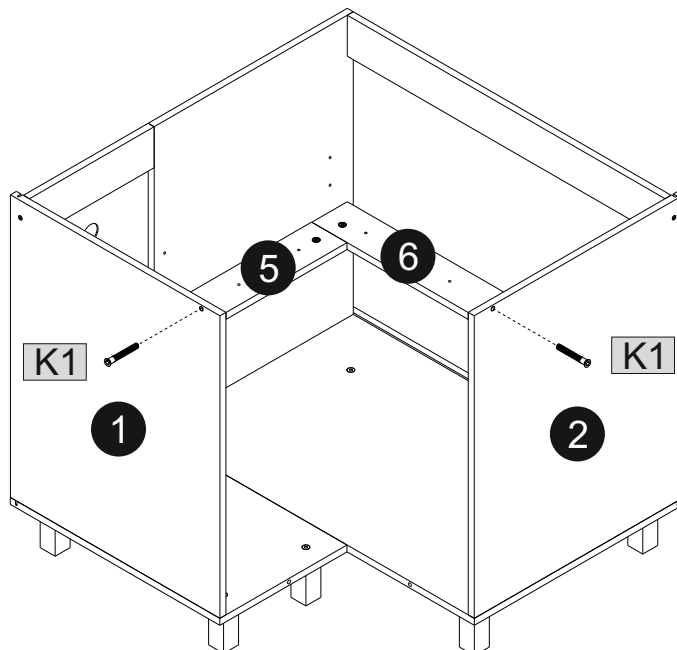
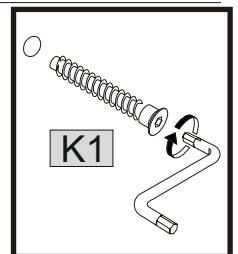

10

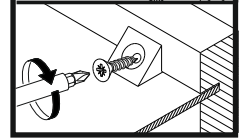
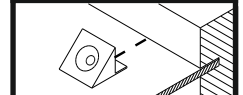
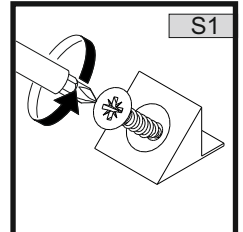
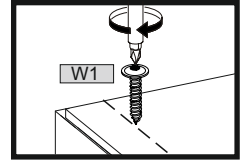
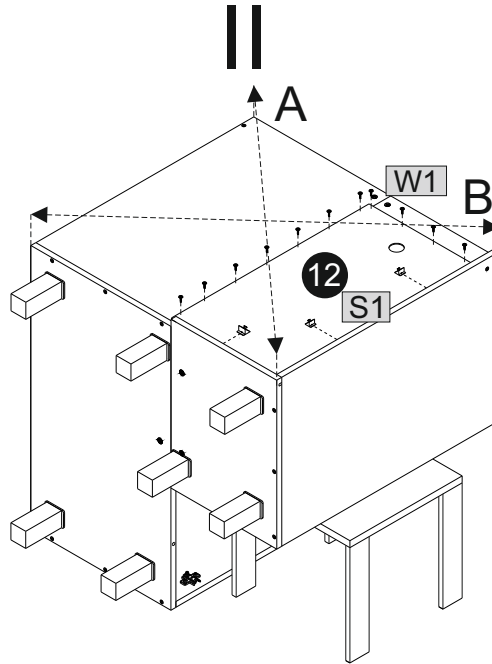
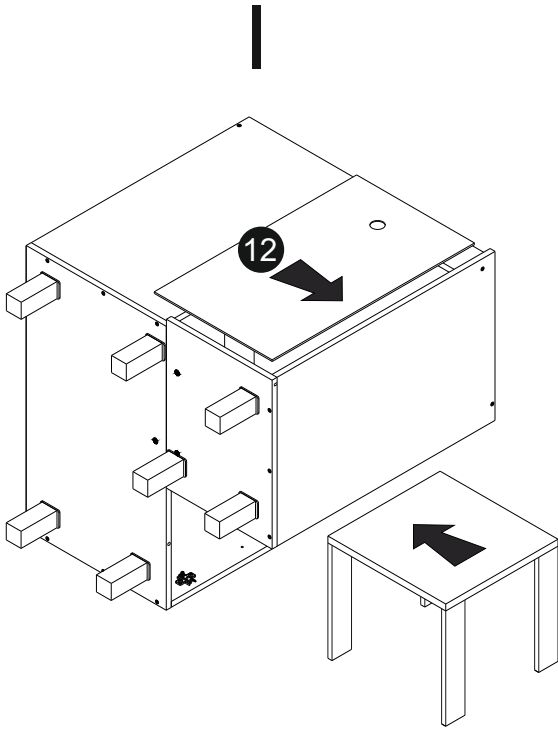
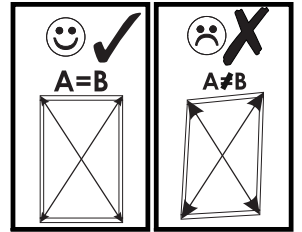
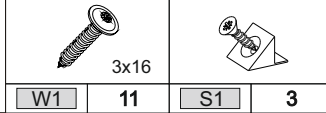
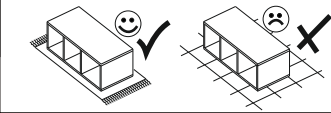

11

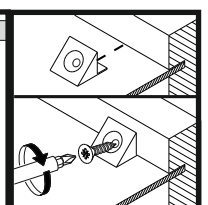
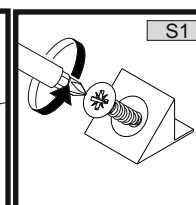
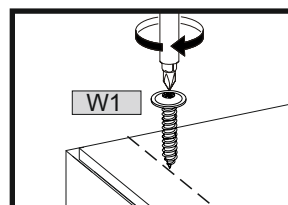
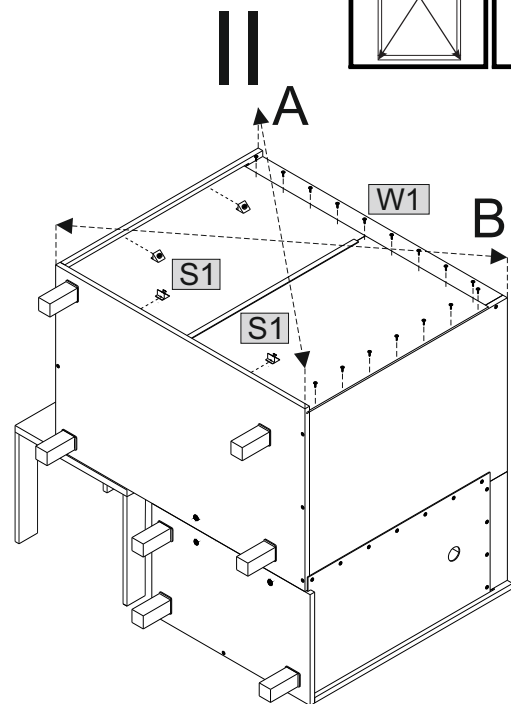
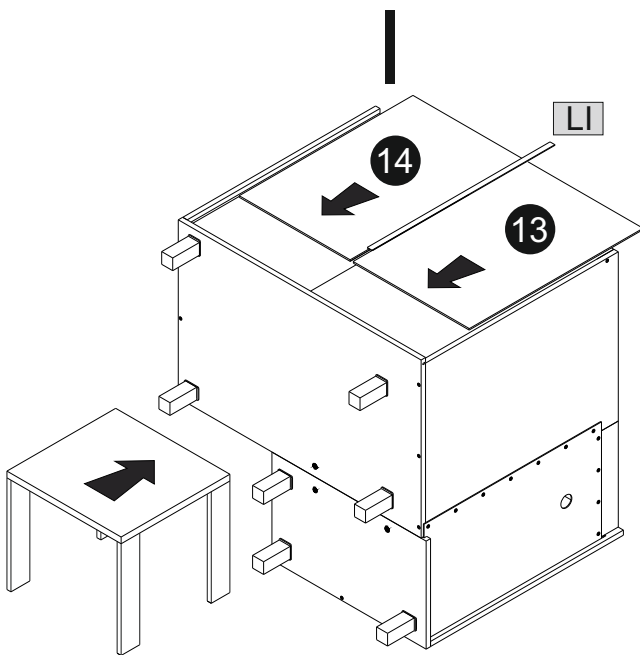
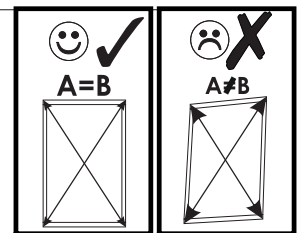
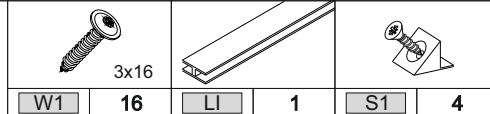
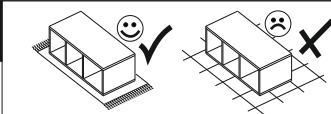

12

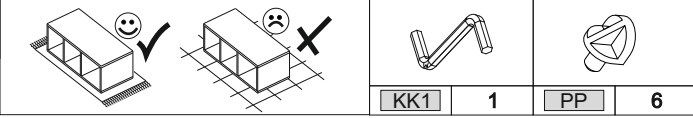

KK1	1	PP	6
-----	---	----	---

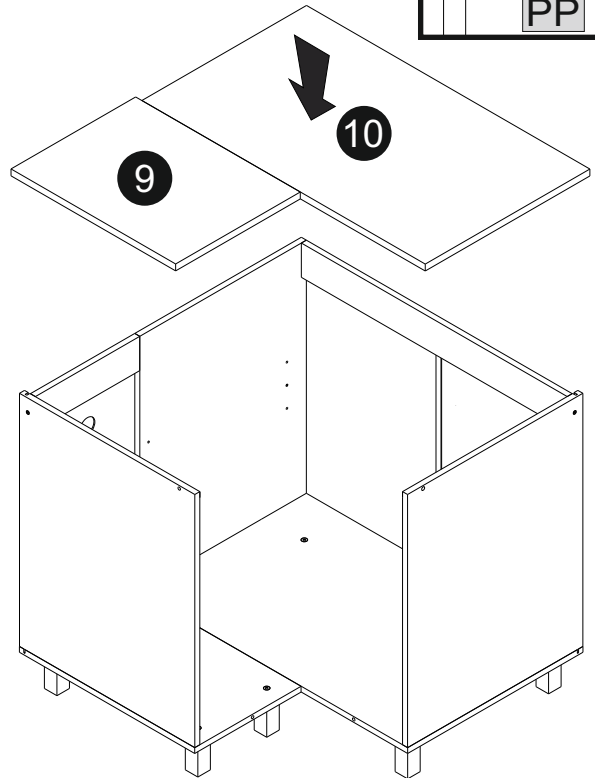
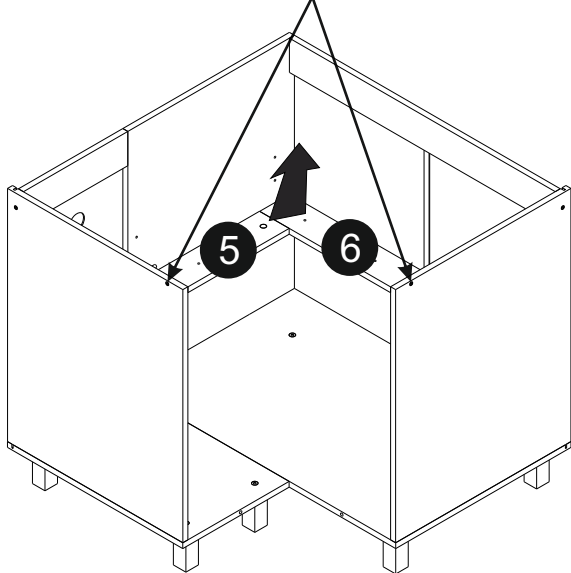
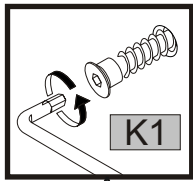
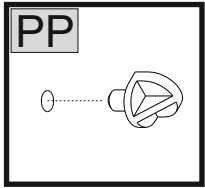
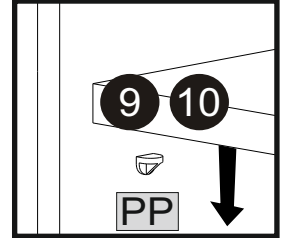

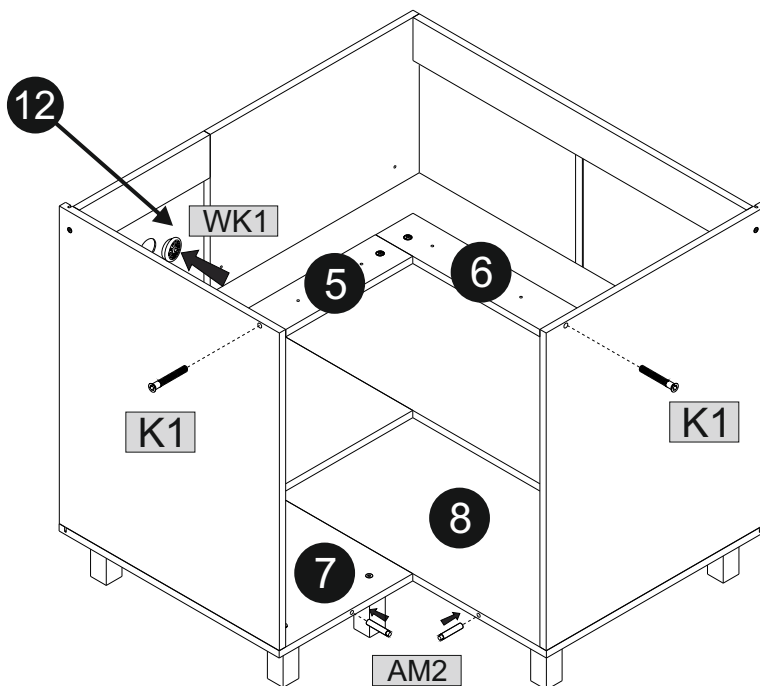
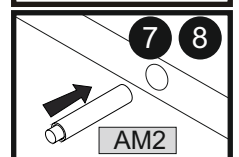
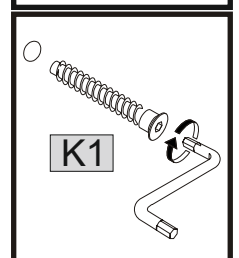
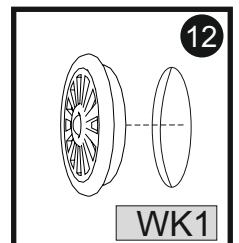

13

	1		2		1		2
		7x50					





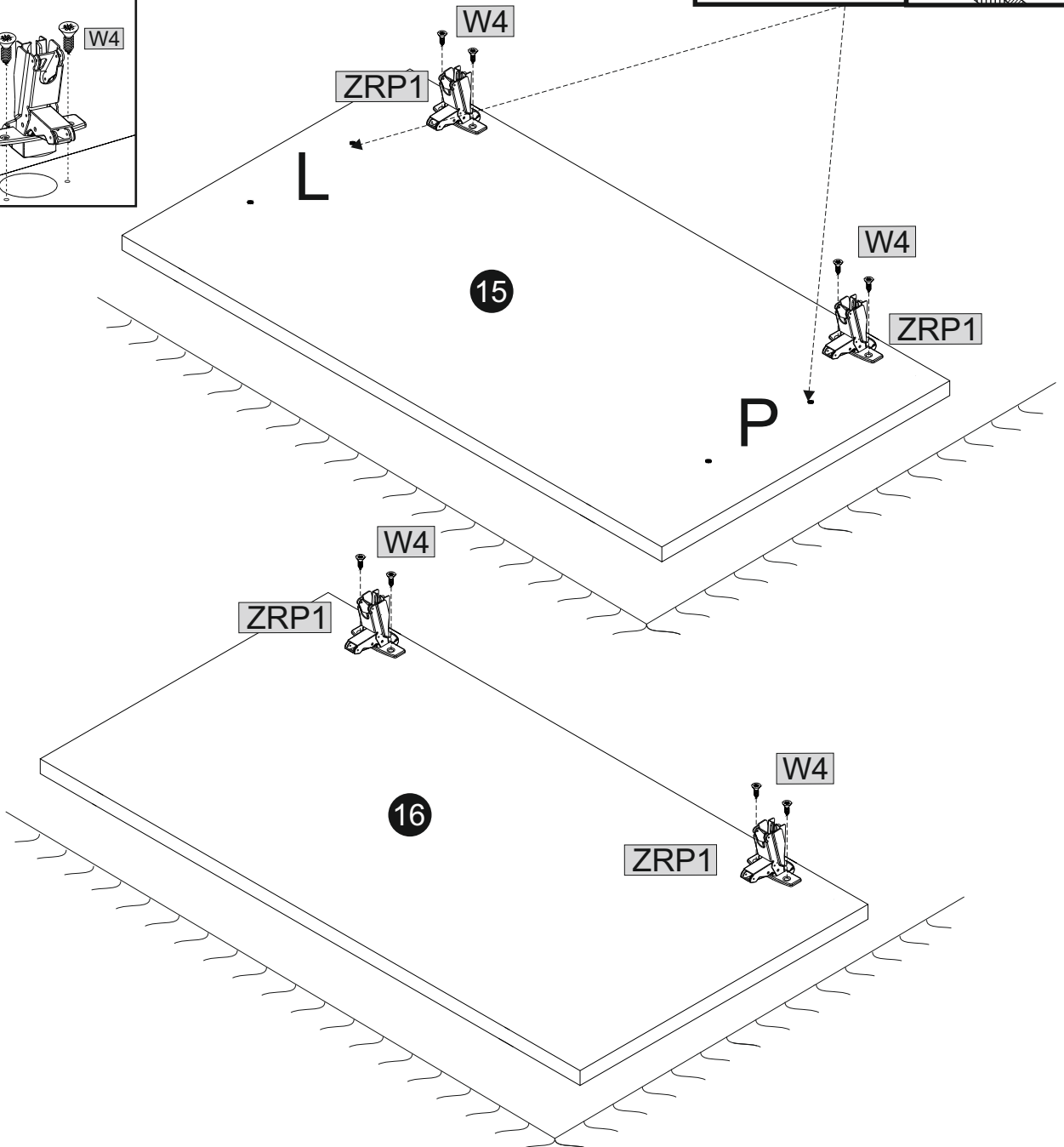
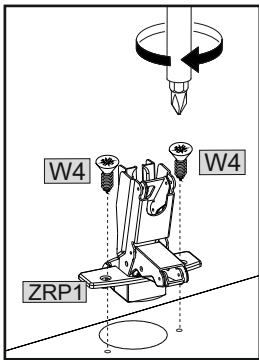
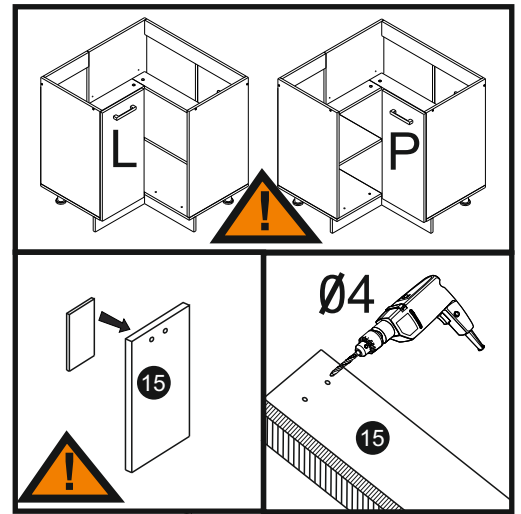
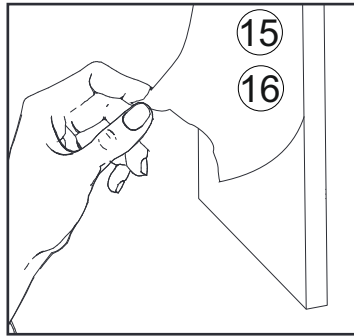
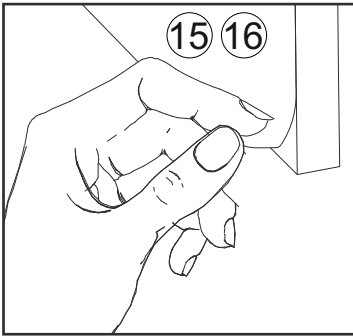

14

			4x13
ZRP1	4	W4	8

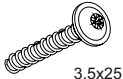

15

				
U75	3,5x25	ZK	4x30	ZM1
1	2	4	4	9

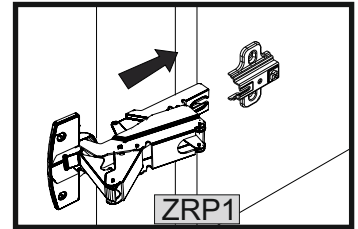

5
Kg

